

M Flex

M Flex 0609HBC M M Flex 0916HBC M Flex 0916HBC M

1

electrical layout

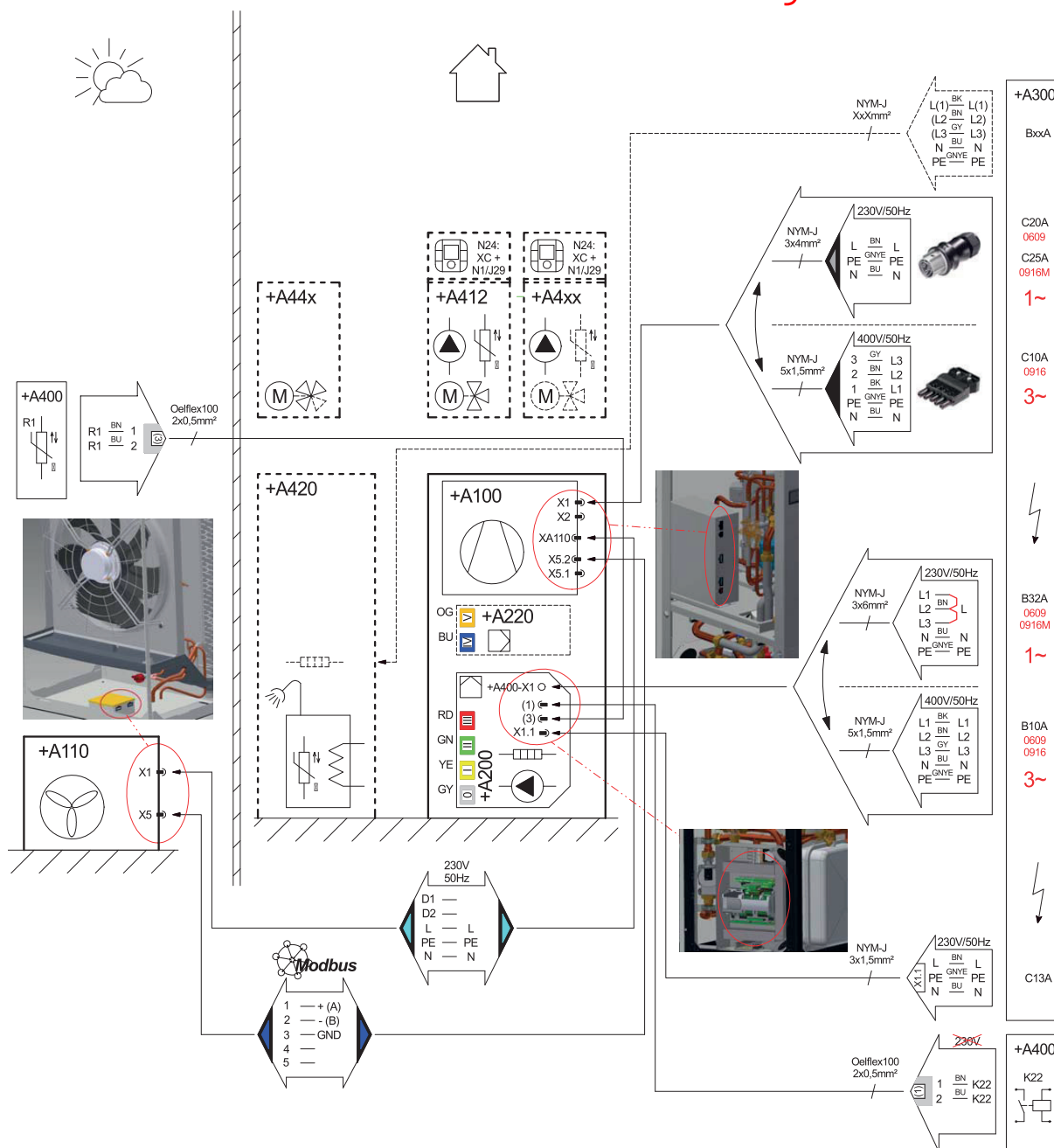



Glen
Dimplex
Deutschland

Dimplex

2



hydraulic

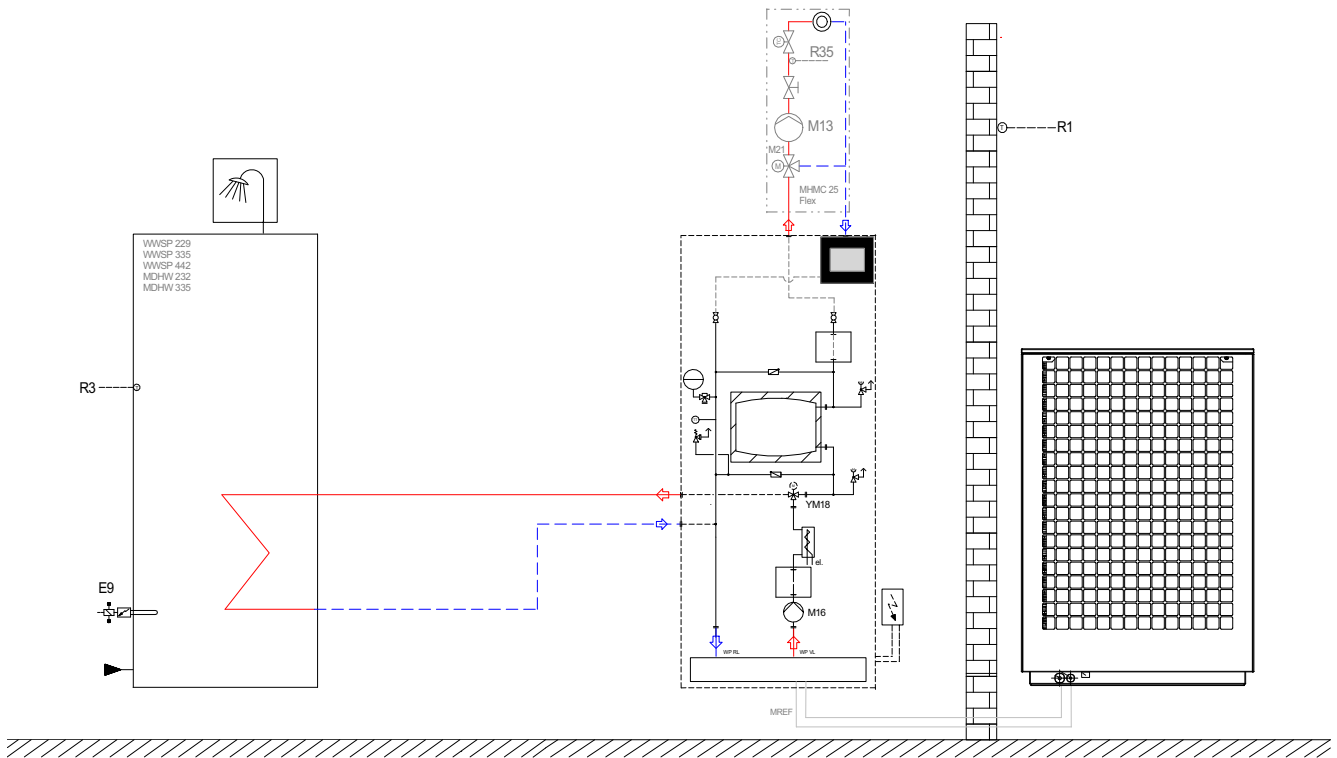

hydraulic 1

3

plug in

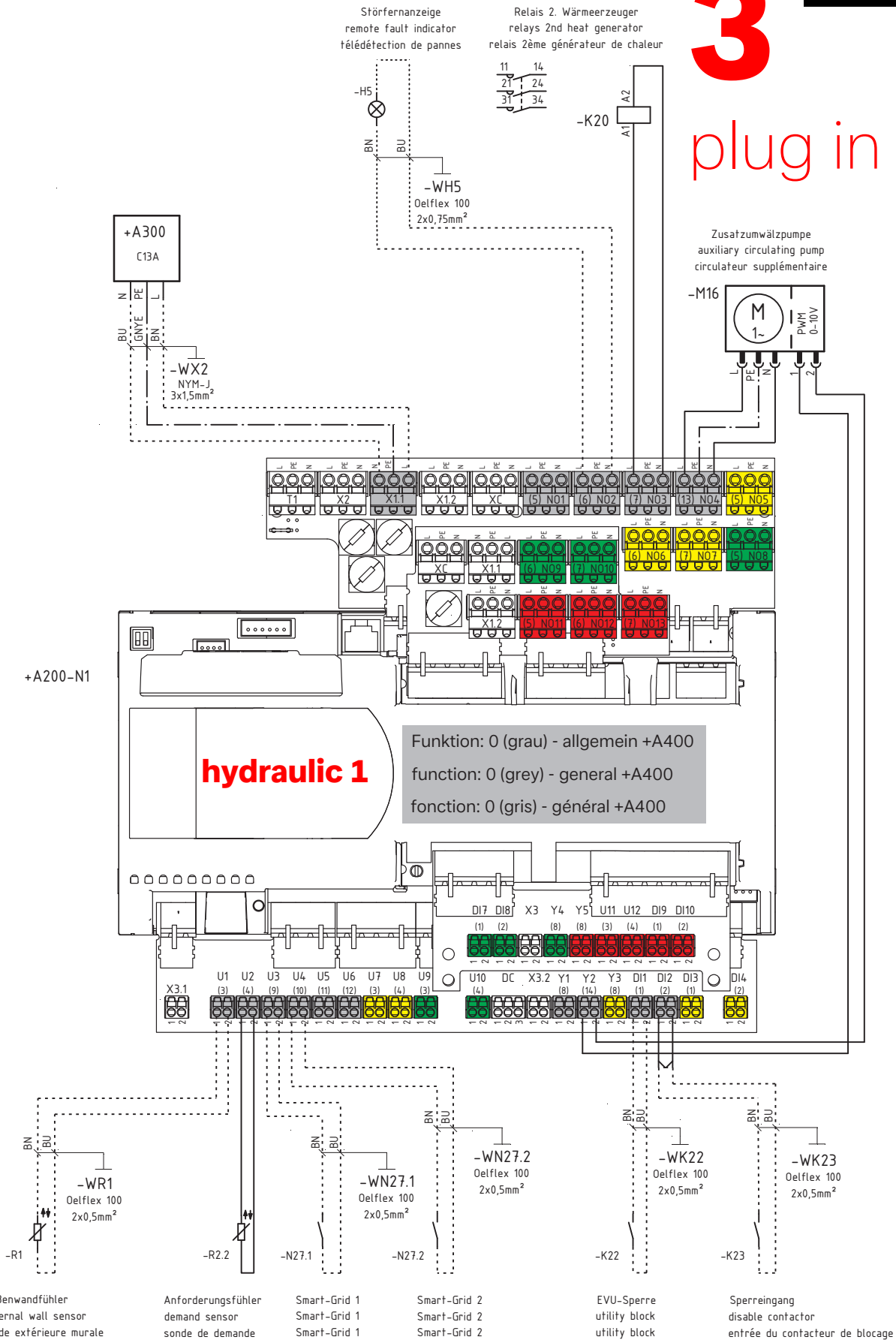



Zirkulationspumpe Warmwasser
circulation pump domestic hot water
circulateur de bouclage ECS eau chaude sanitaire

Relais Flanschheizung -E9
relays flange heater -E9
relais cartouche chauffante -E9

Umschaltventil Warmwasser
reversing valve domestic hot water
vanne d'inversion eau chaude sanitaire

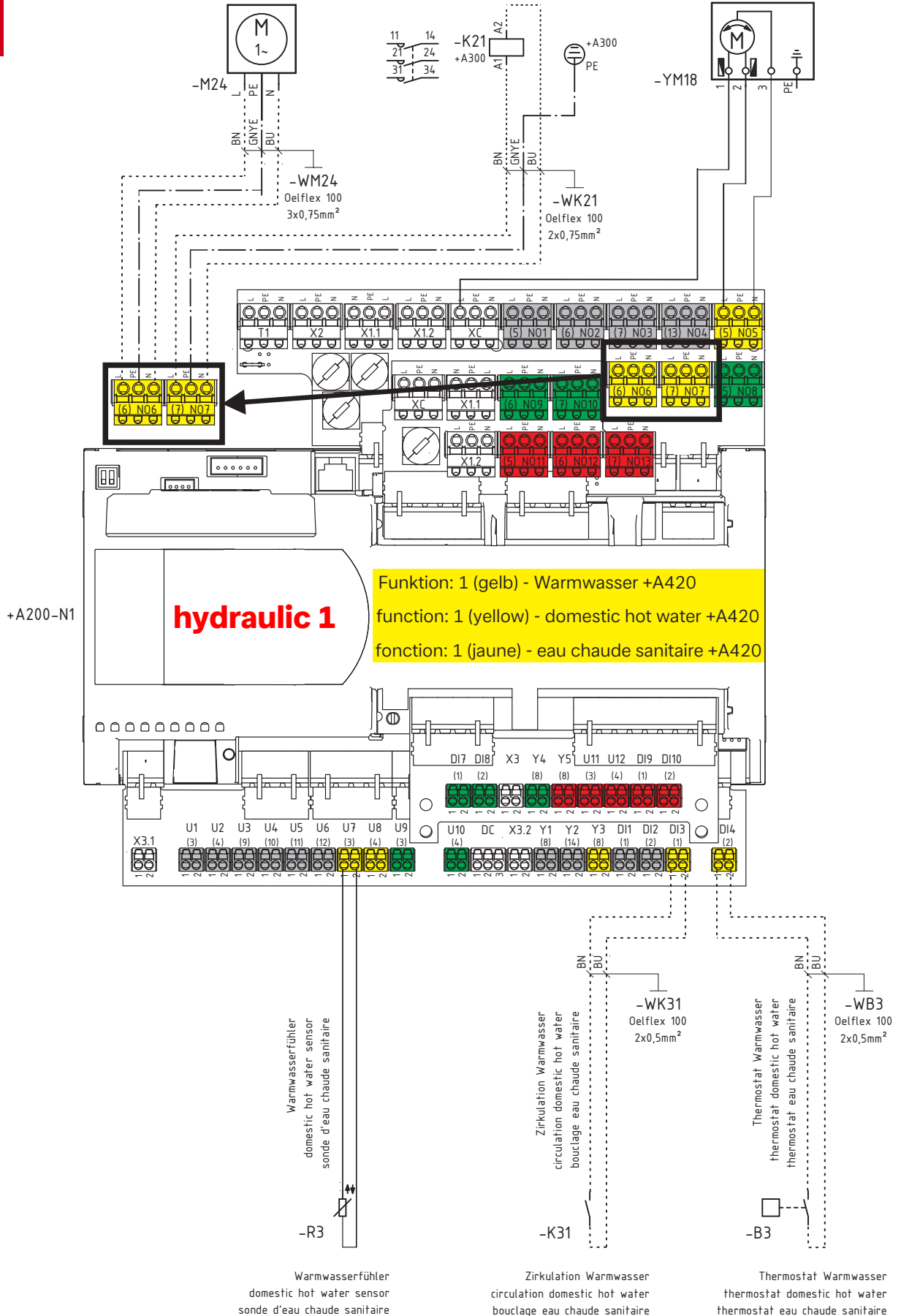

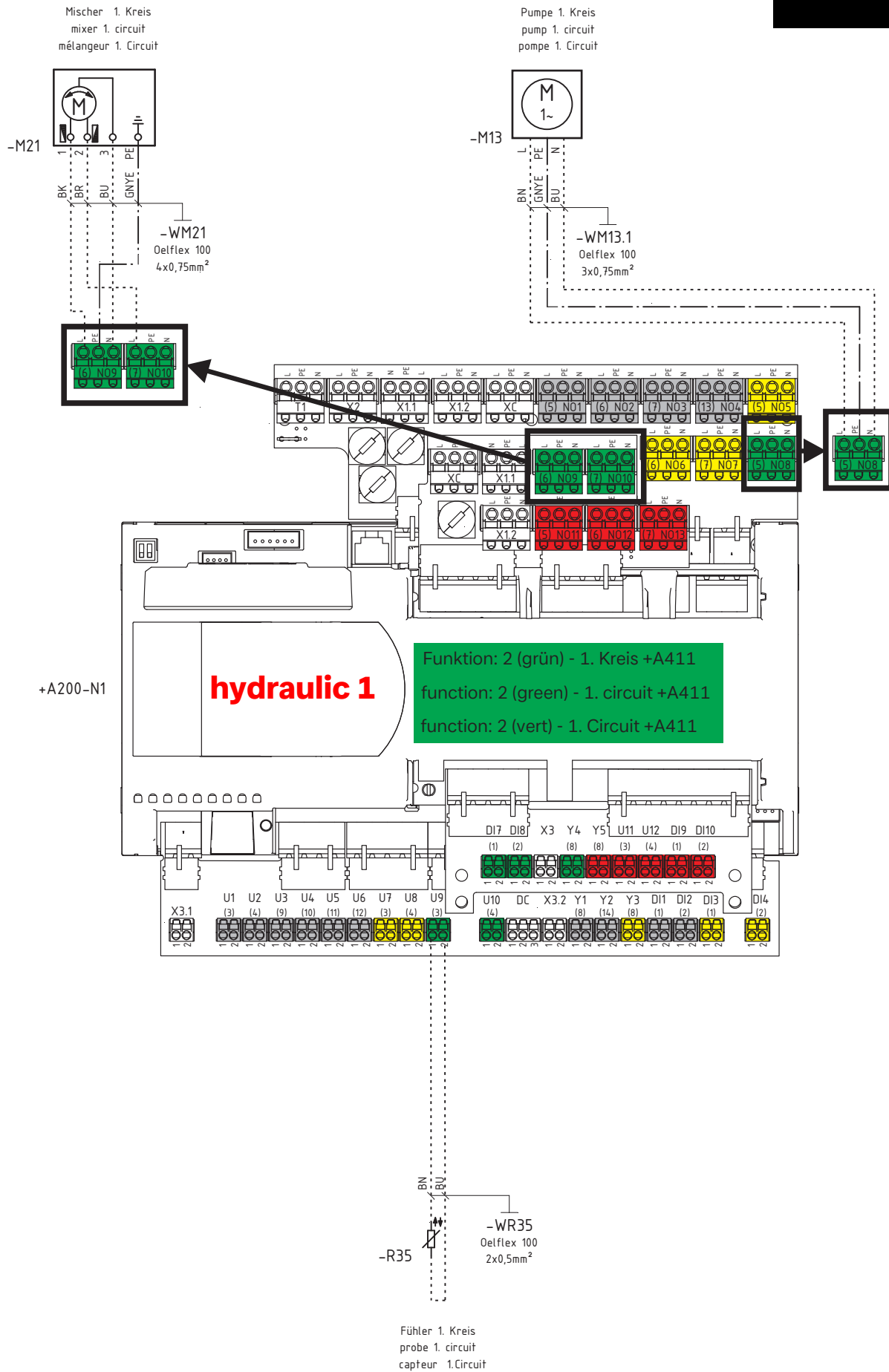

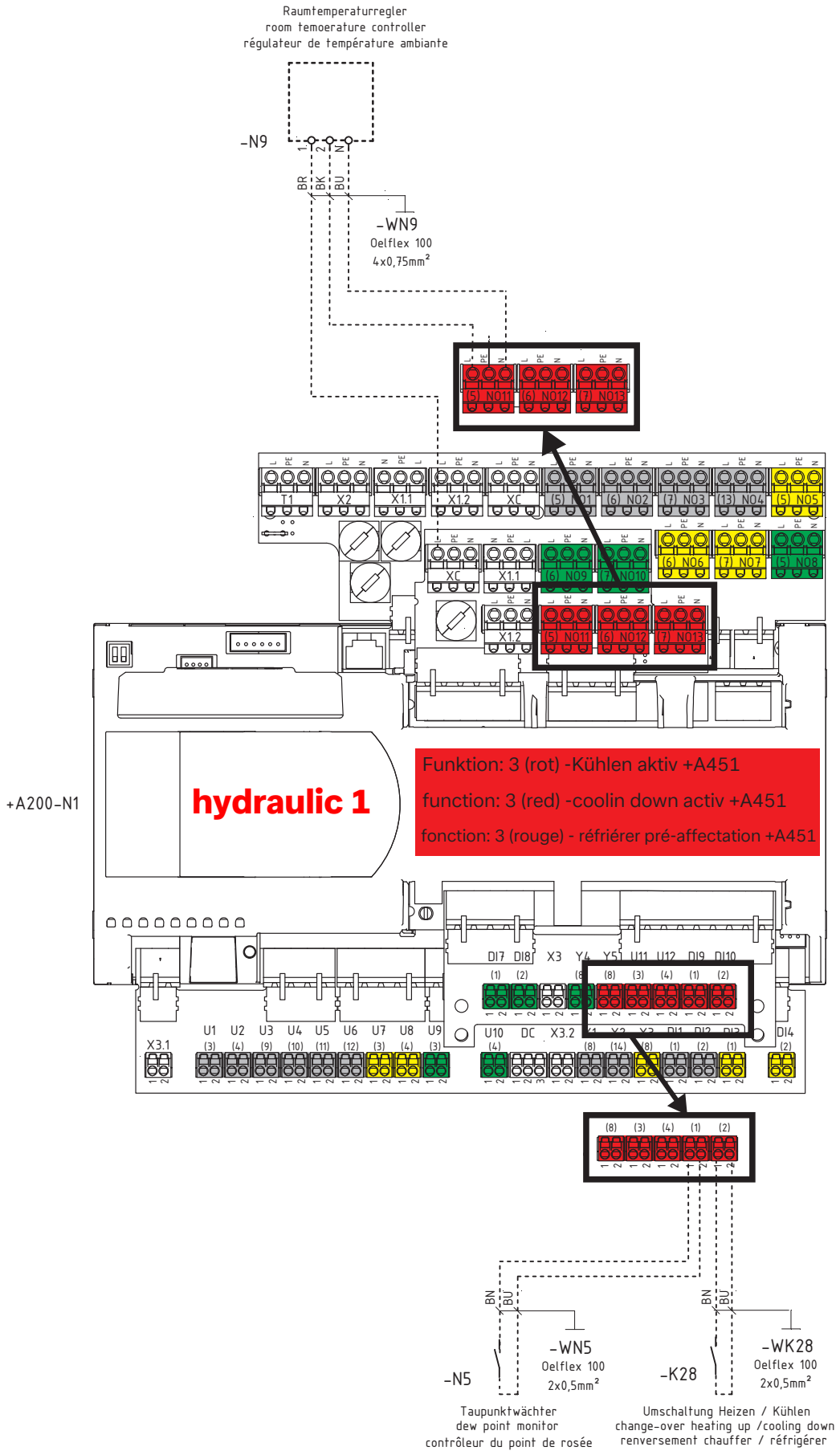



4



hydraulic

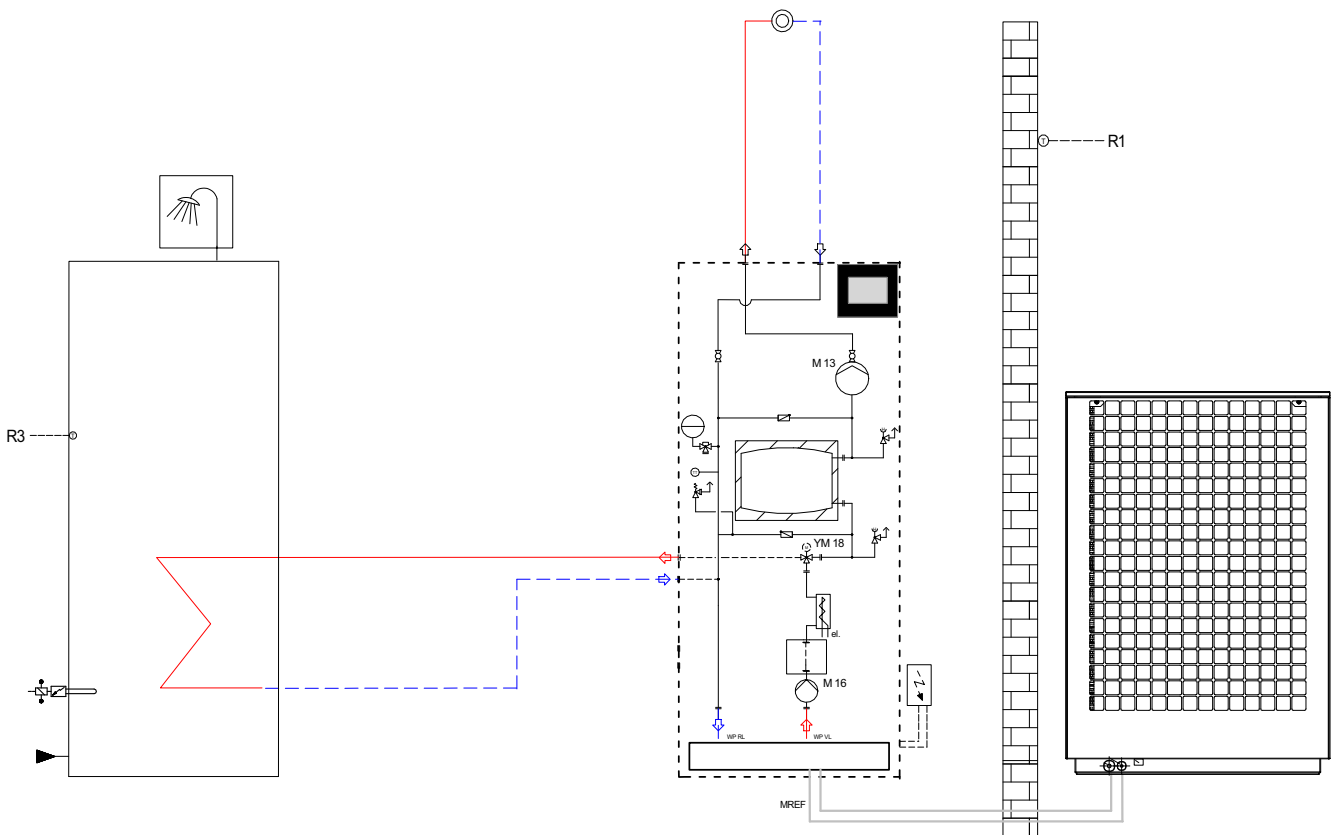

hydraulic 2

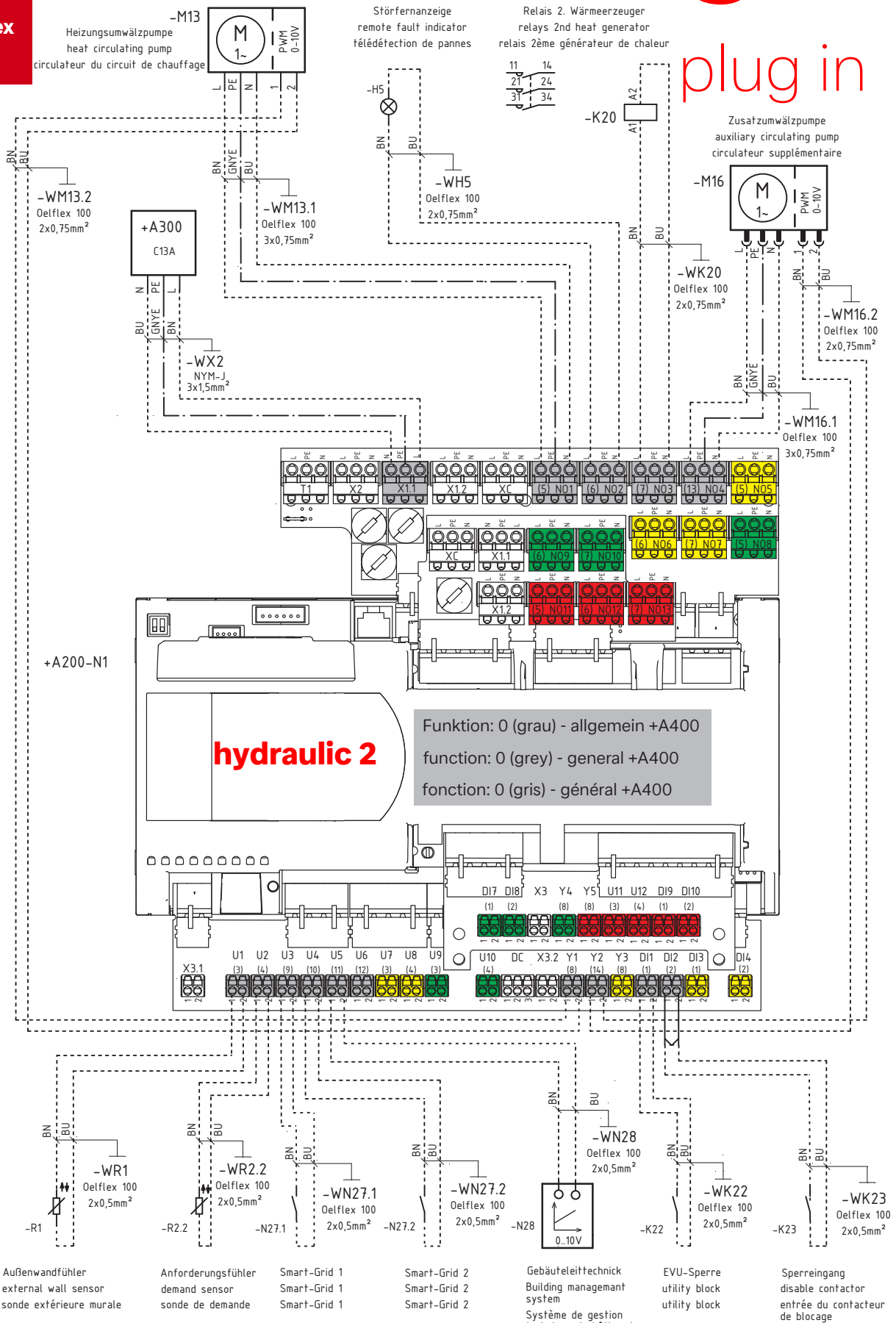

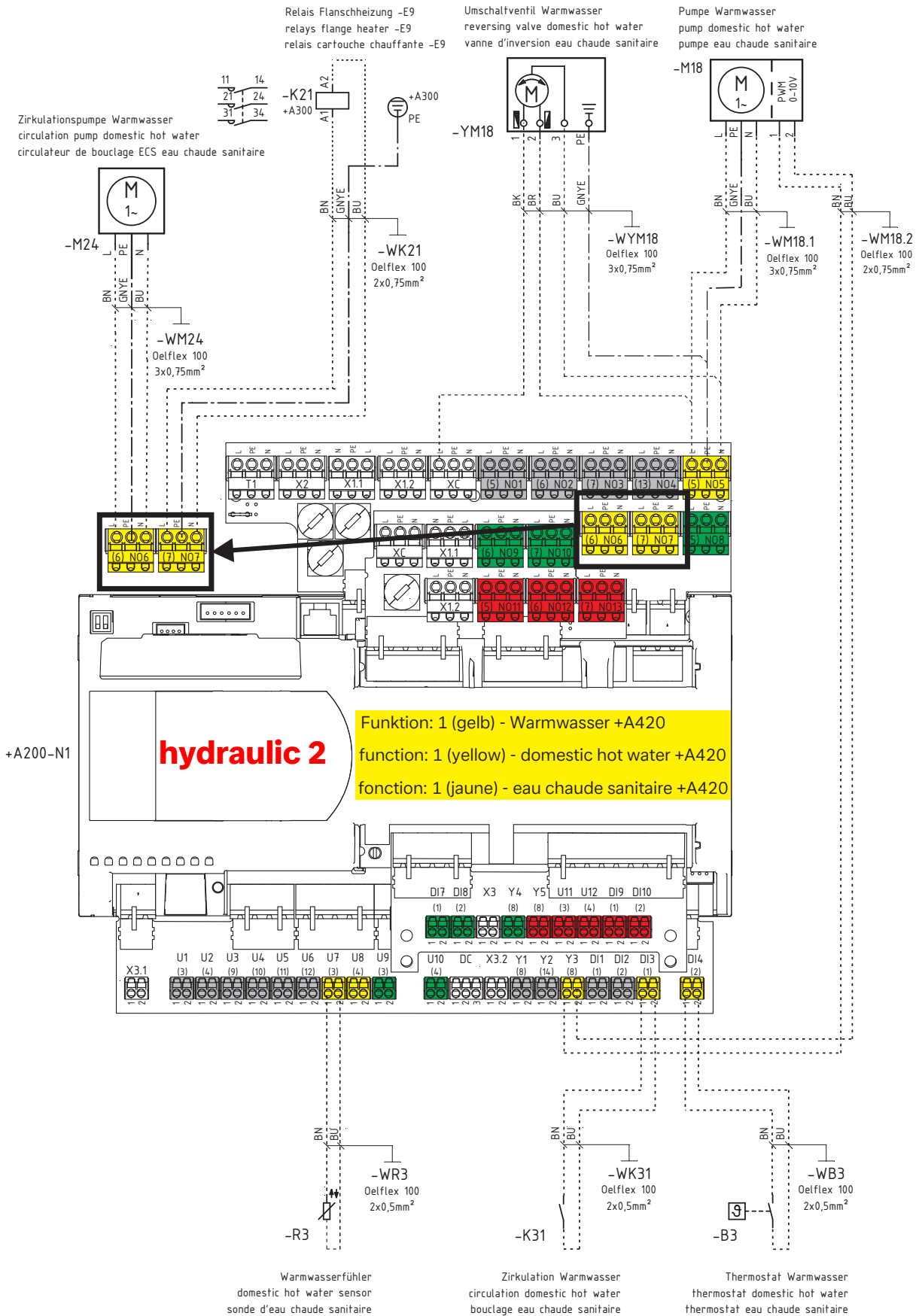



**Glen
Dimplex**
Deutschland

Dimplex