



Powietrzna pompa ciepła

LA 18S-TUR

1

schemat elektryczny

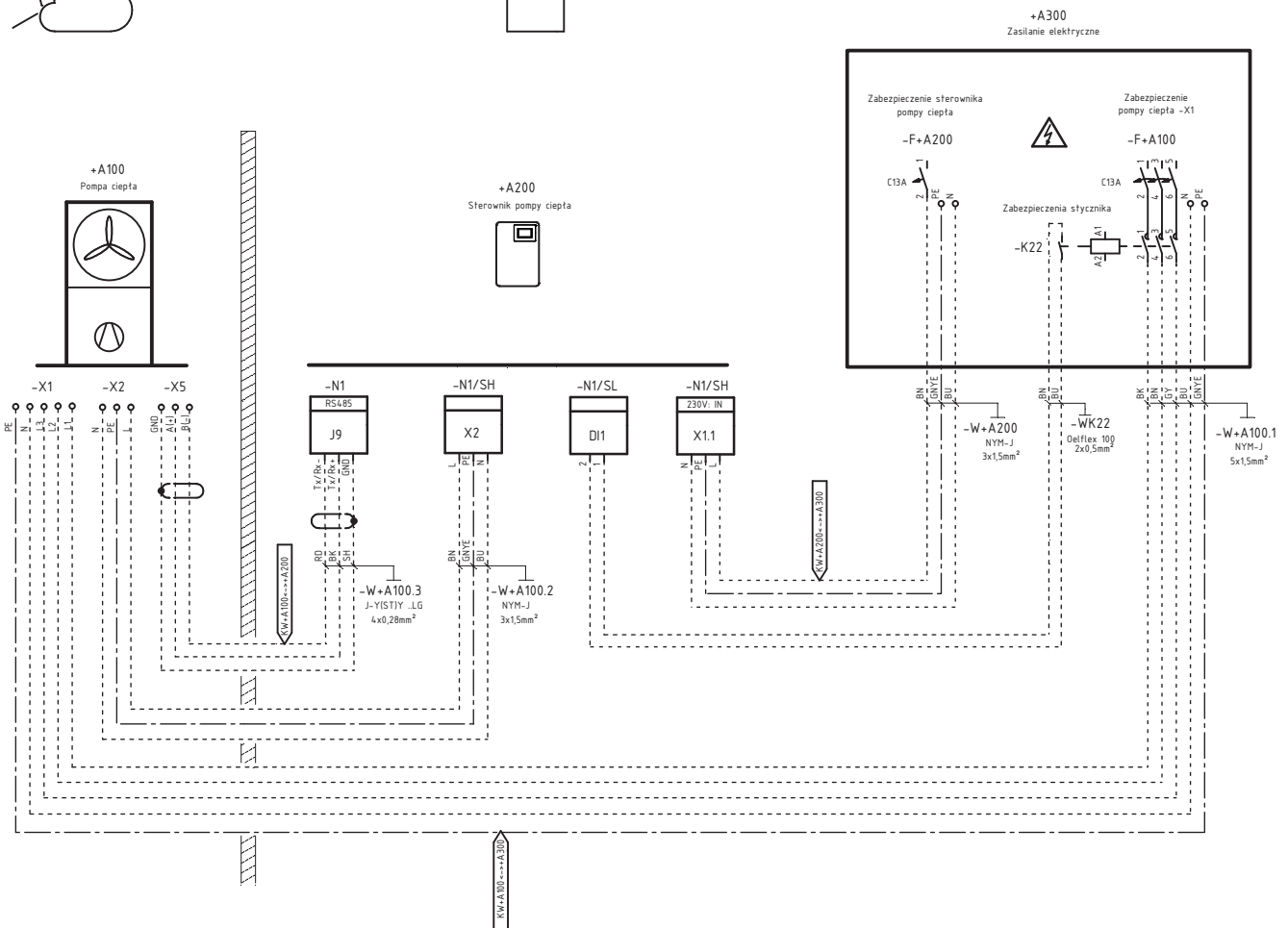



2

schemat hydrauliczny

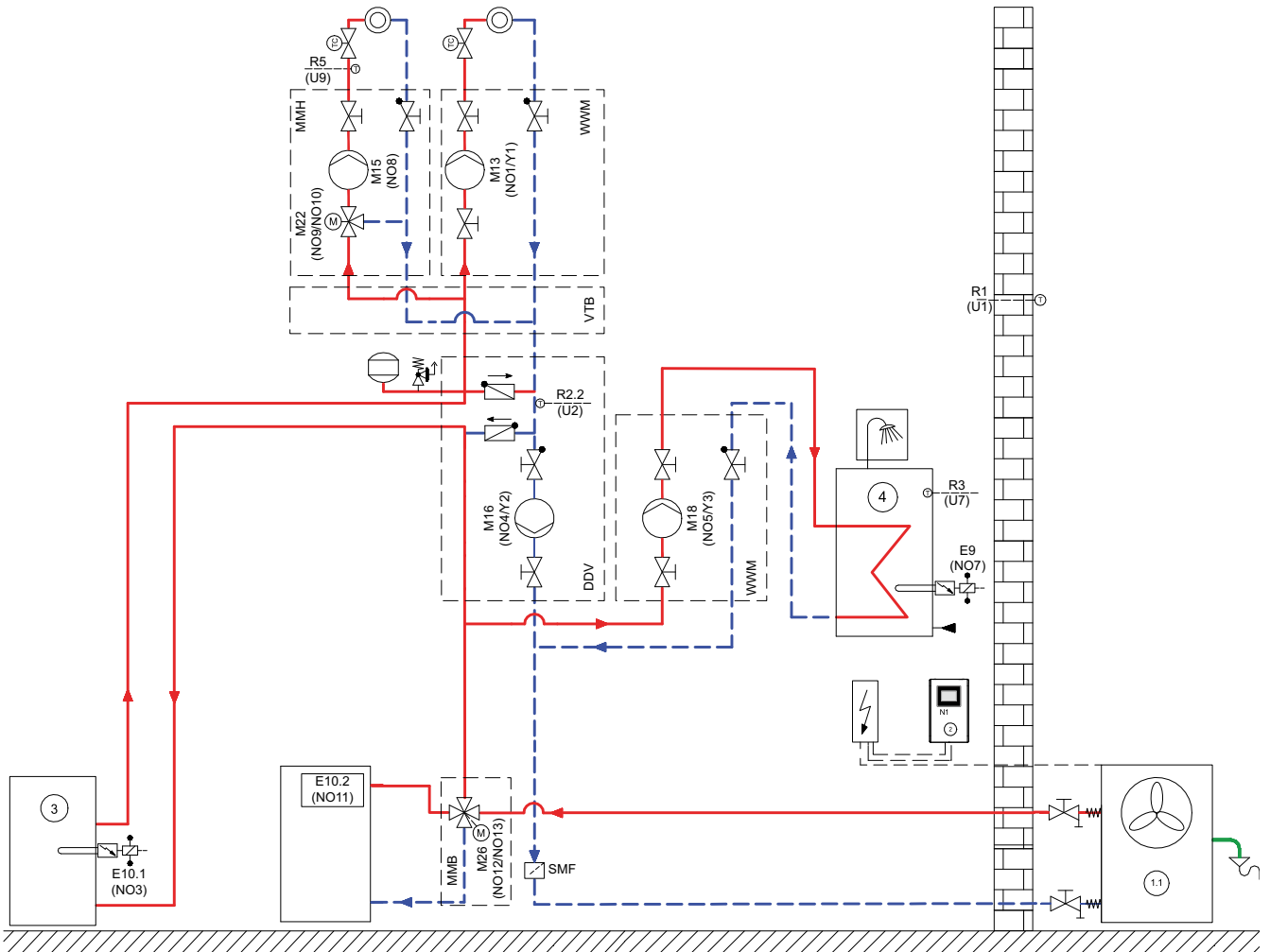

Schemat hydrauliczny 1

3

podłączenie

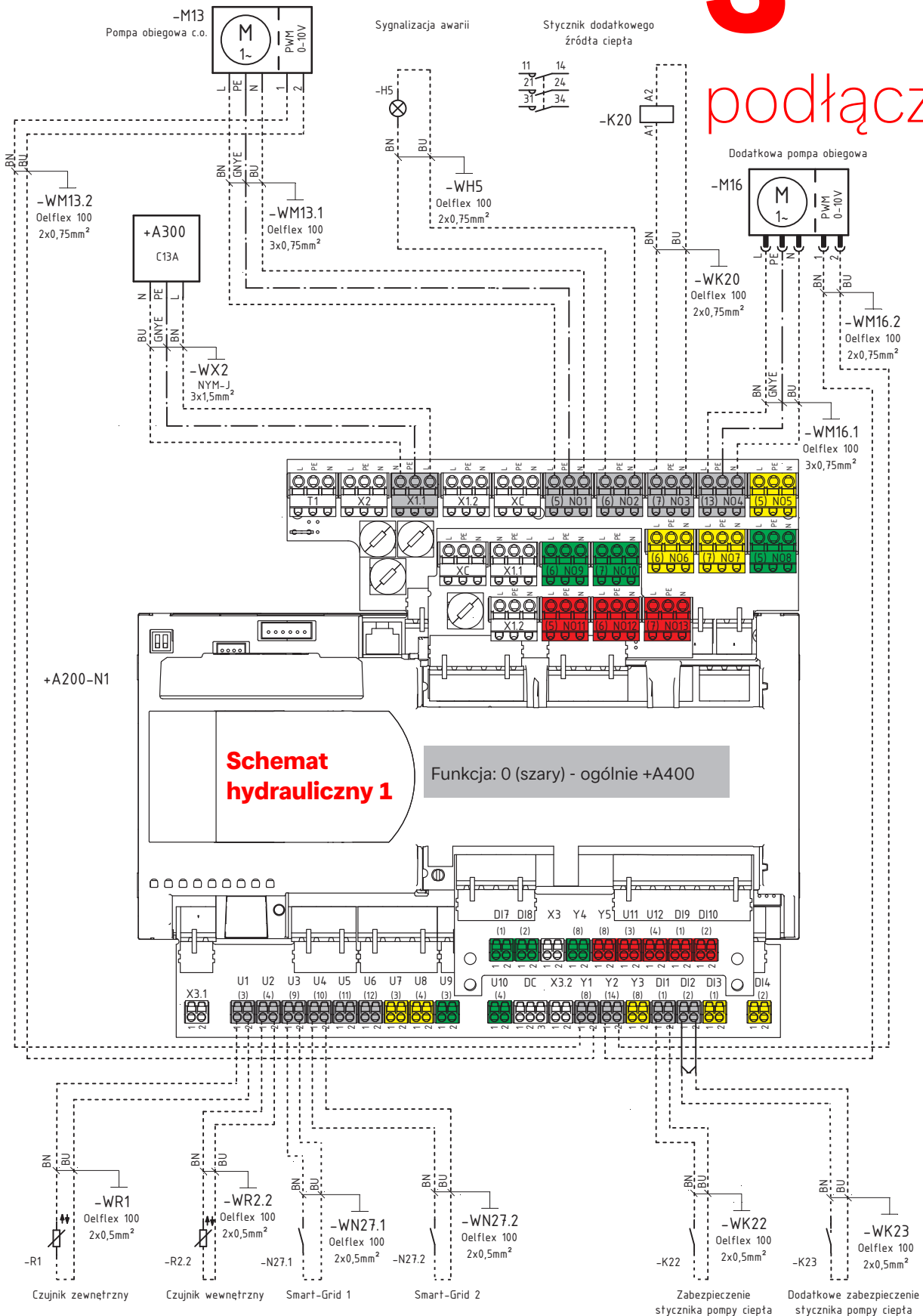

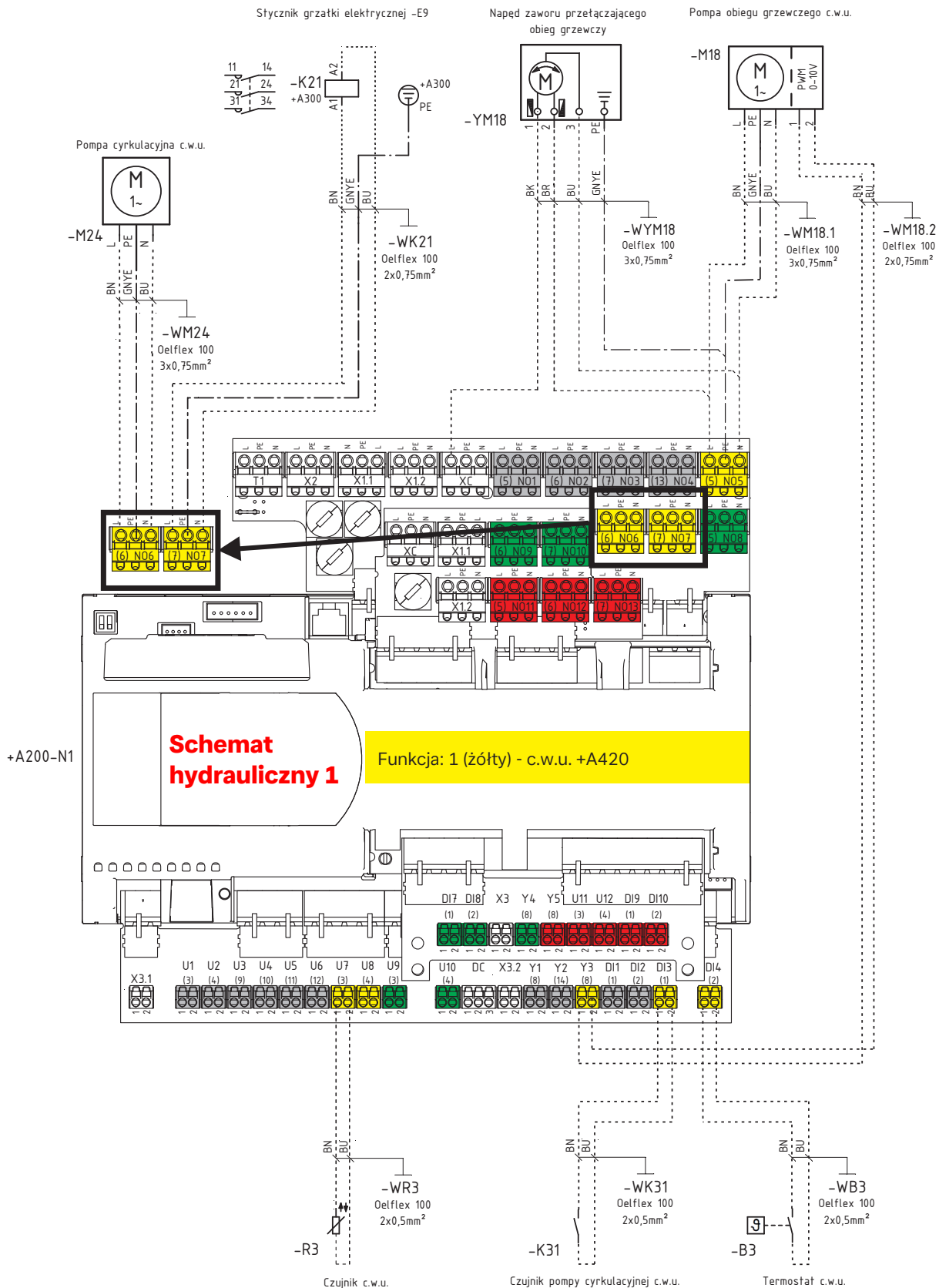

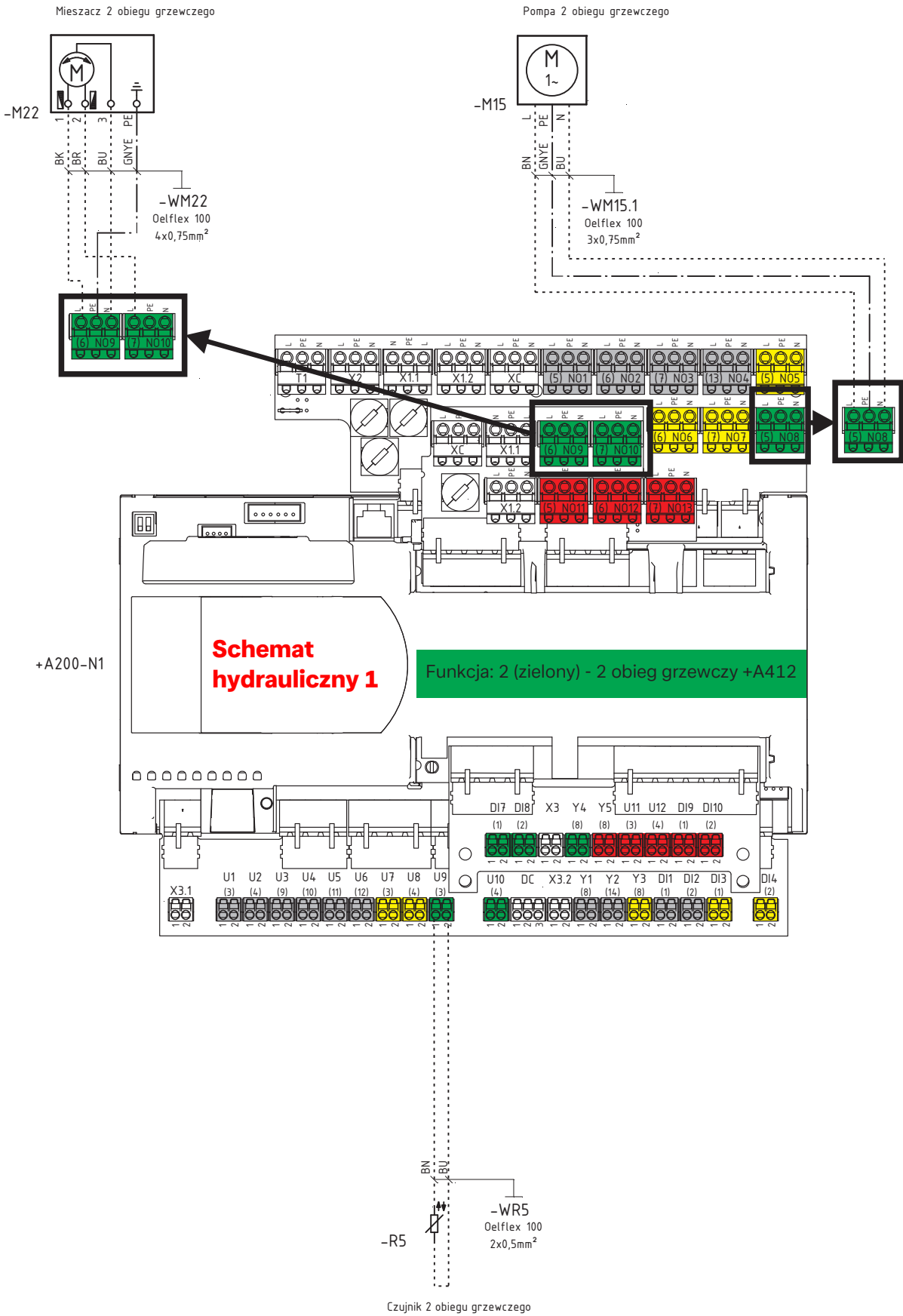



Glen
Dimplex
Deutschland

Dimplex

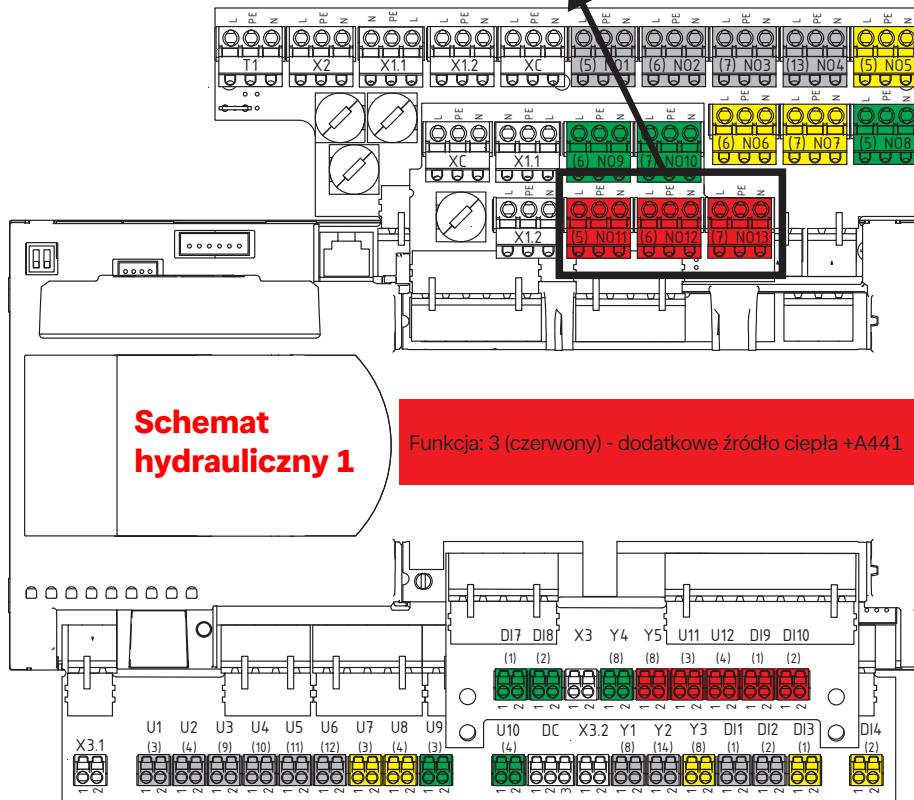
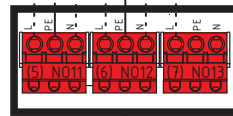
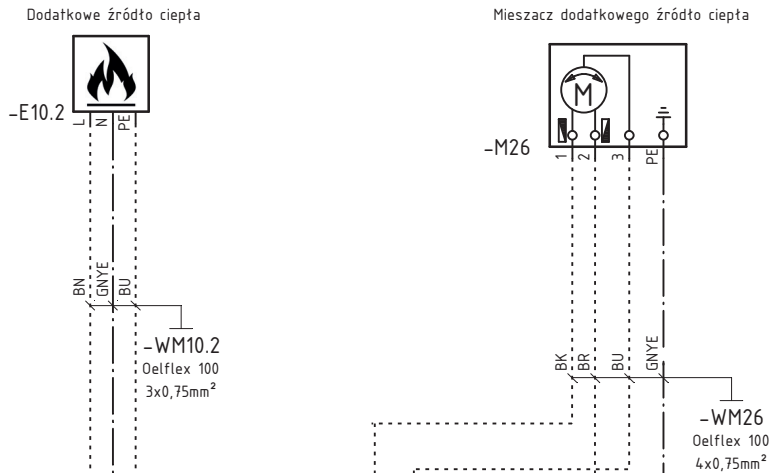

4



schemat hydrauliczny

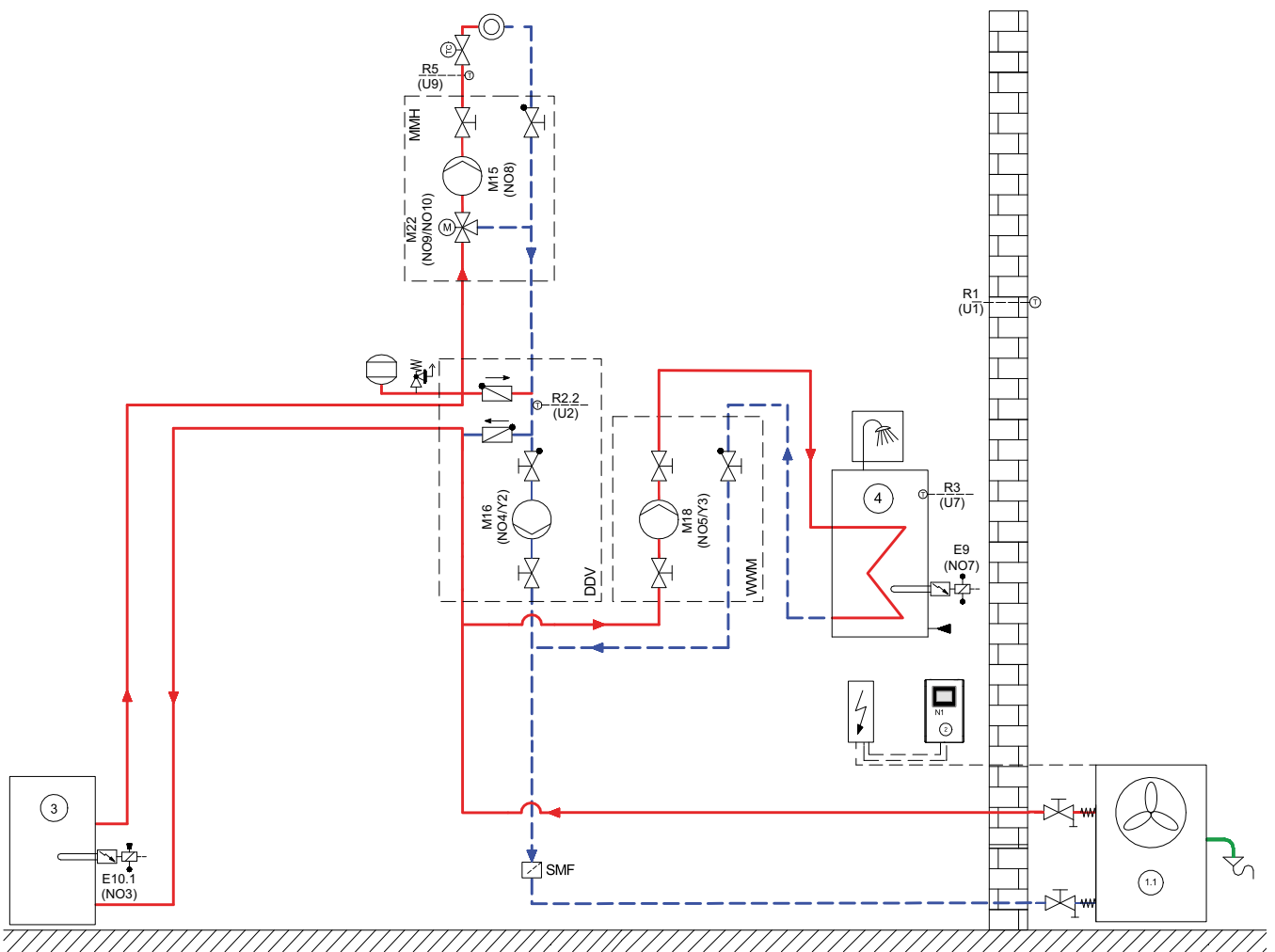

Schemat hydrauliczny 2

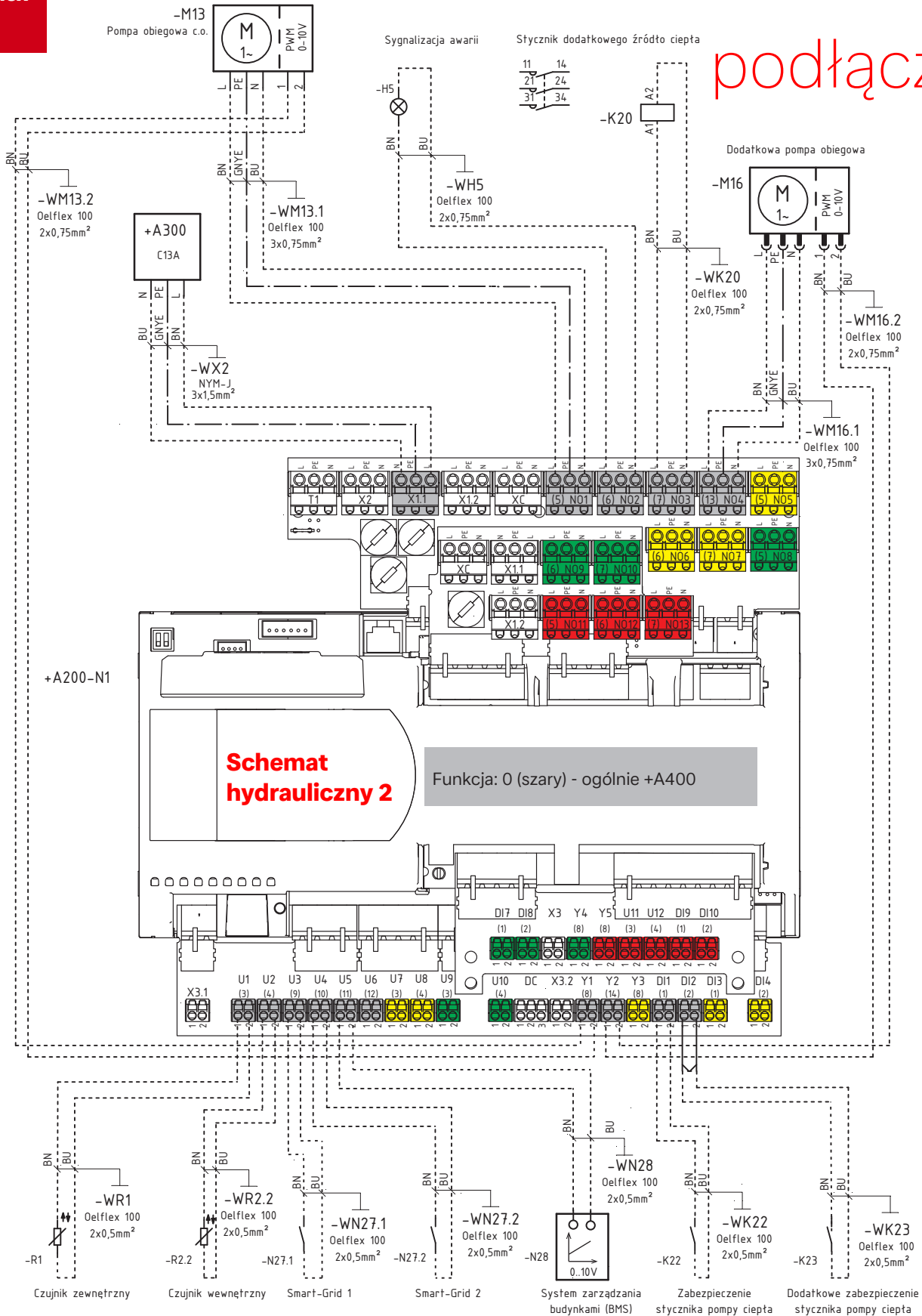

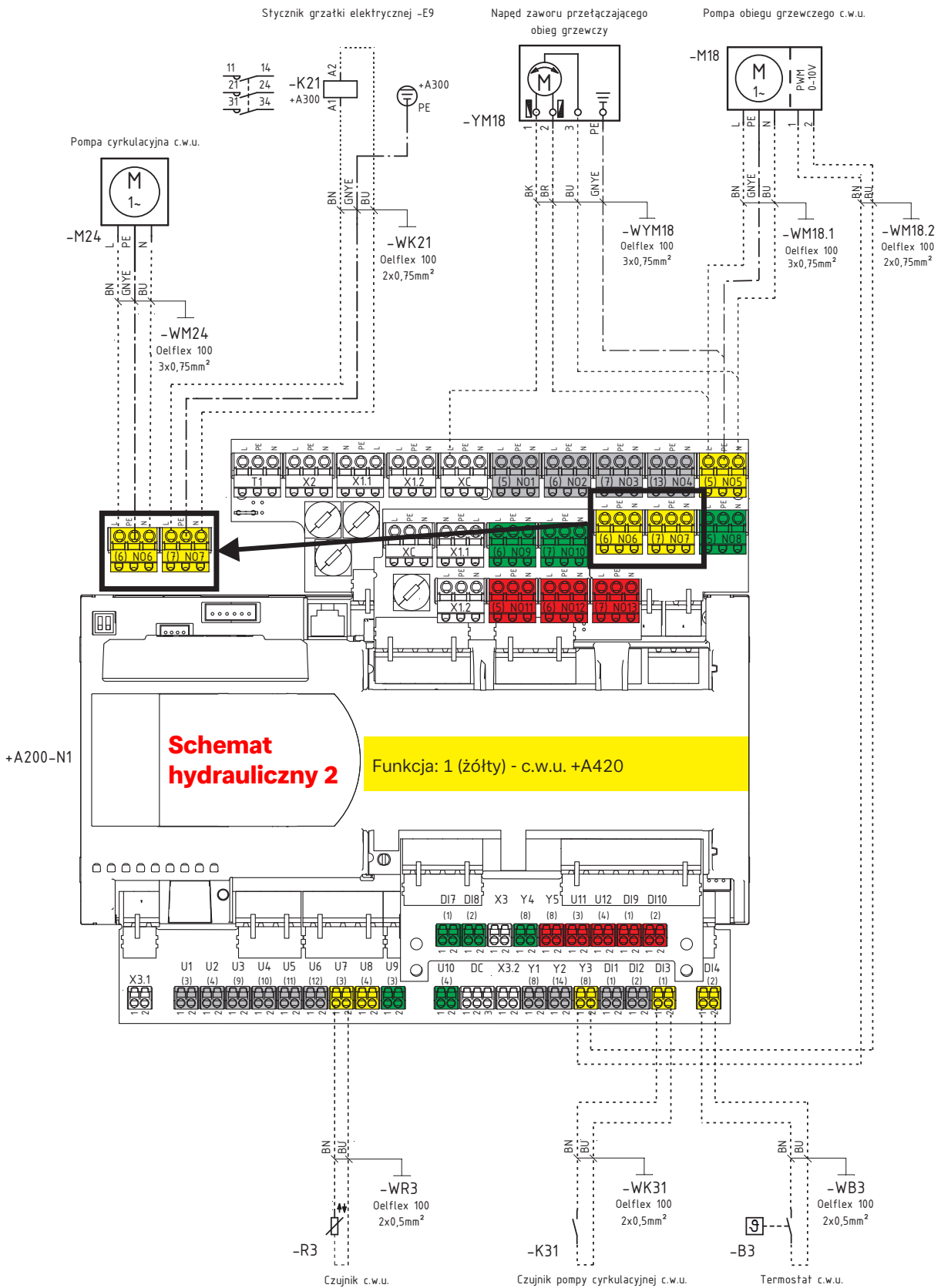



Glen
Dimplex
Deutschland

Dimplex

Mieszacz 2 obiegu grzewczego

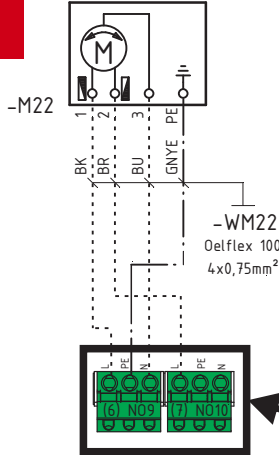

Pompa 2 obiegu grzewczego

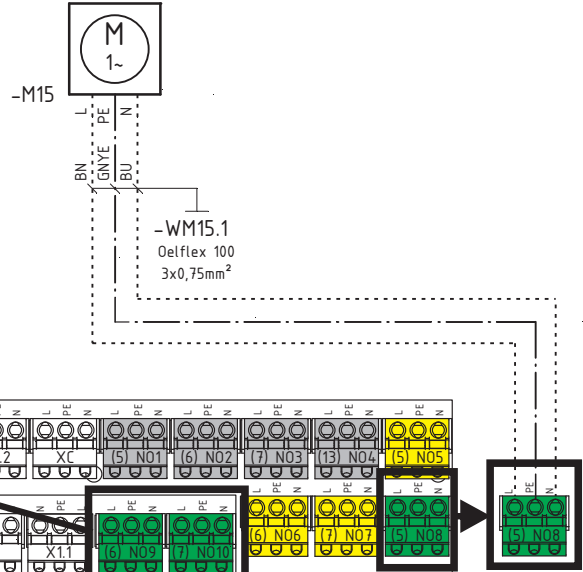

+A200-N1

Schemat hydrauliczny 2

Funkcja: 2 (zielony) - 2 obieg grzewczy +A412

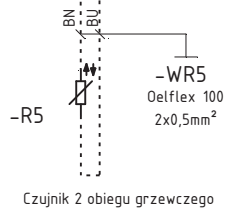
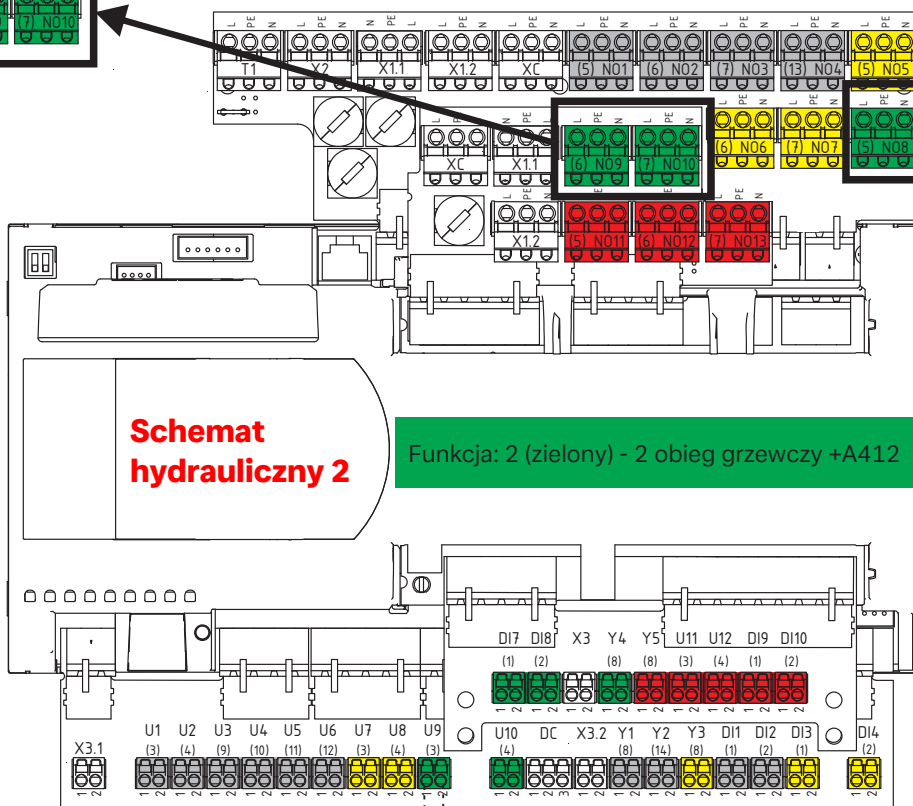

Czujnik 2 obiegu grzewczego

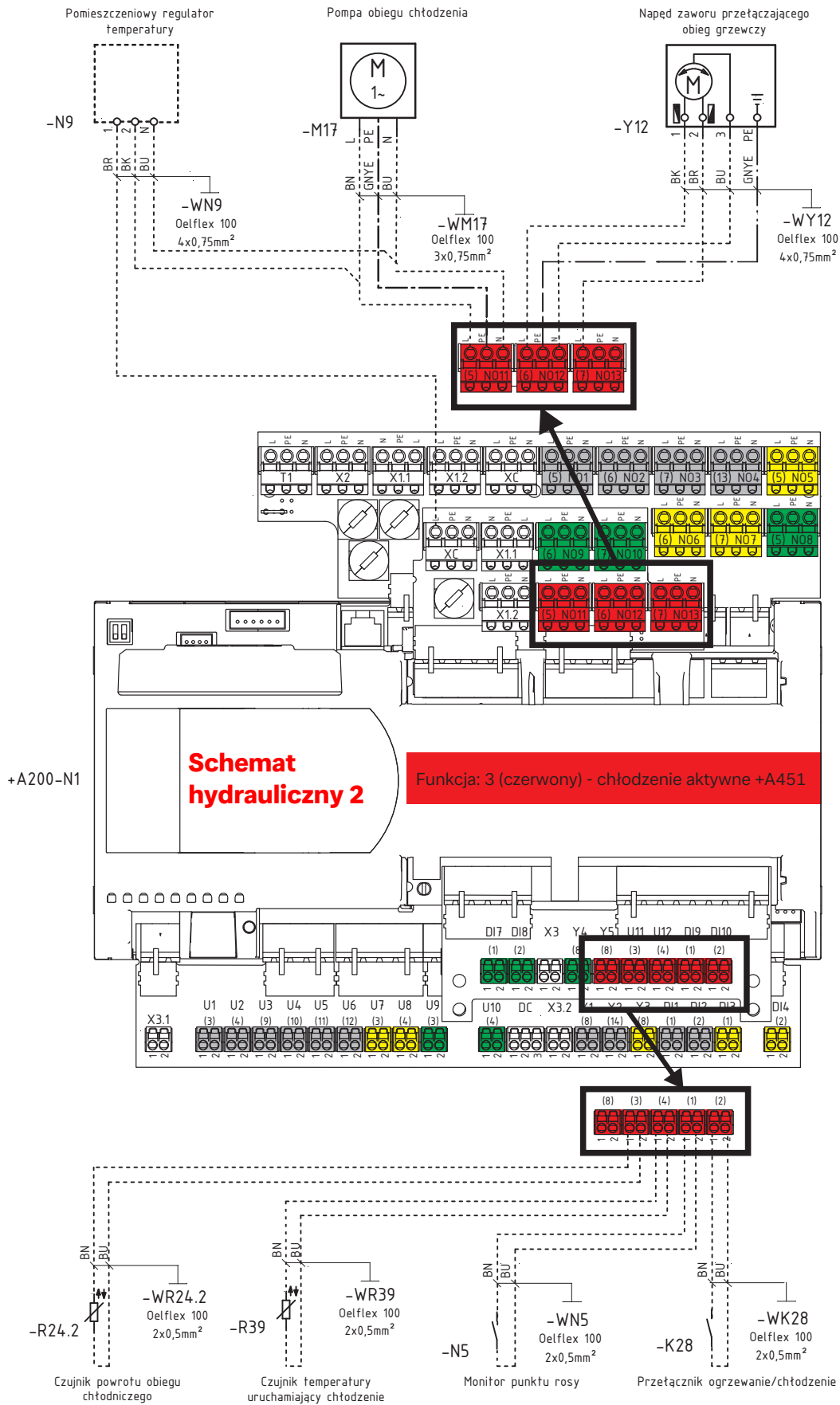



**Glen
Dimplex**
Deutschland

Dimplex