



Powietrzna pompa ciepła

LA 6S-TUR

1

schemat elektryczny

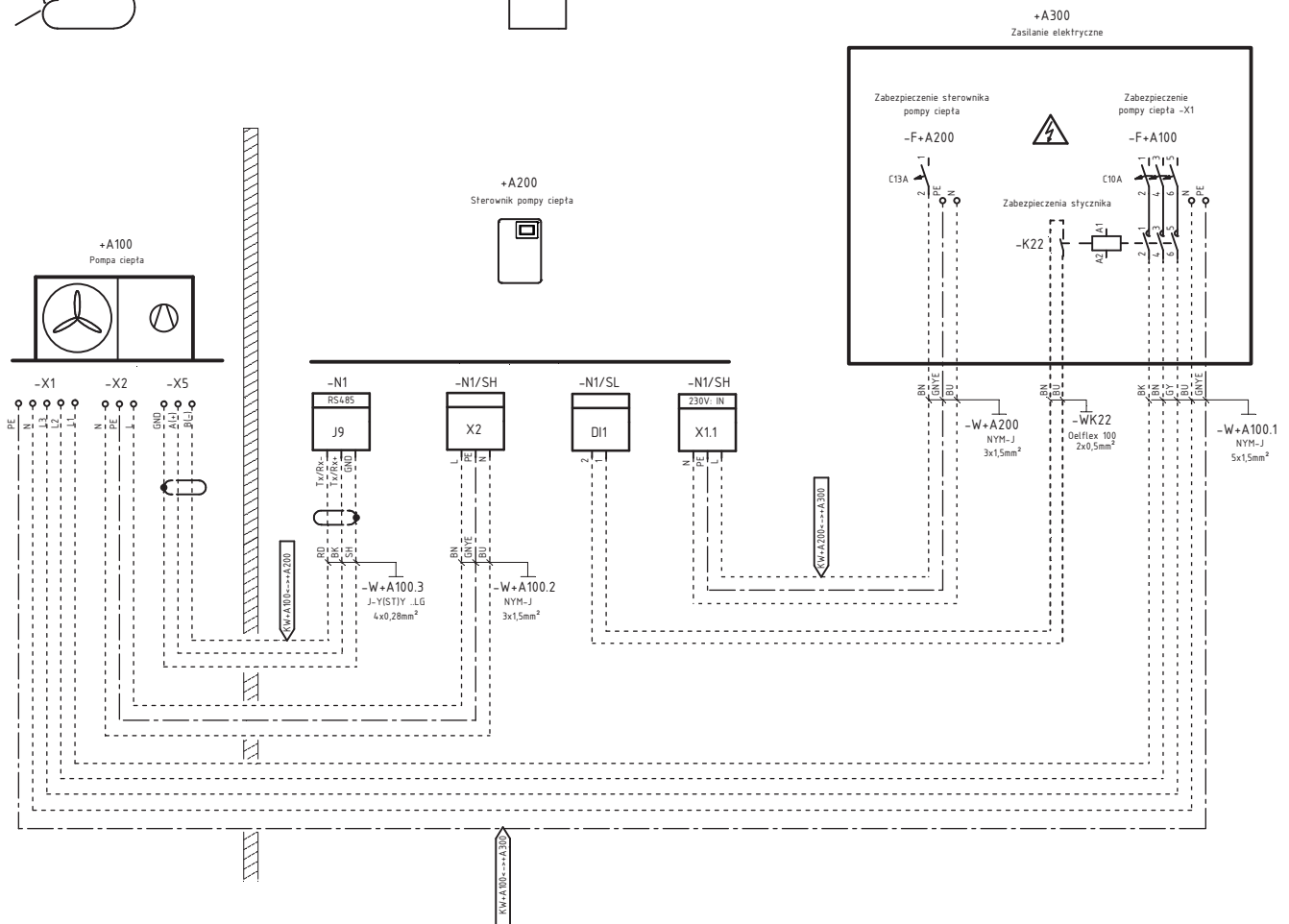



2

schemat hydrauliczny

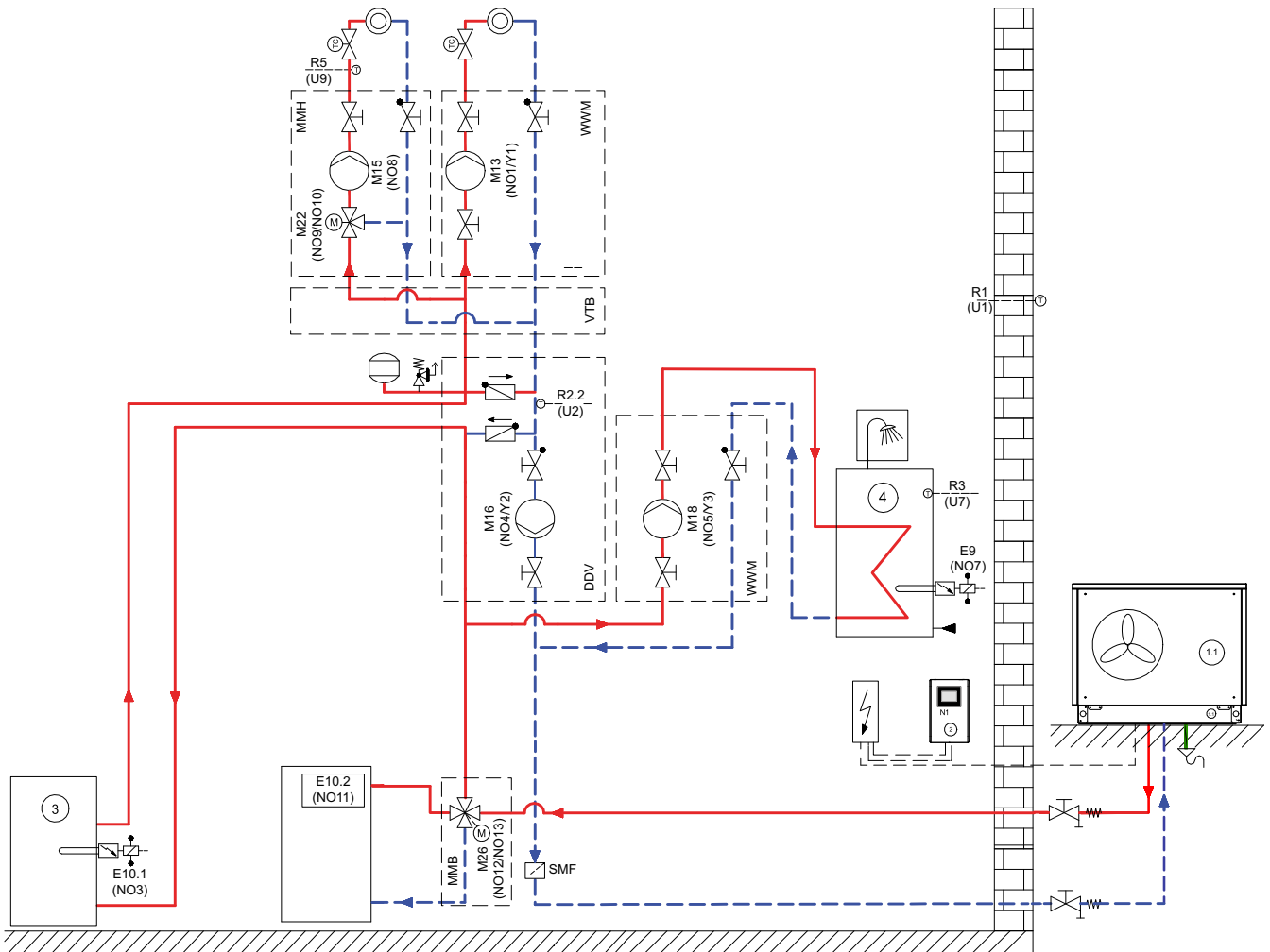

Schemat hydrauliczny 1

3

podłączenie

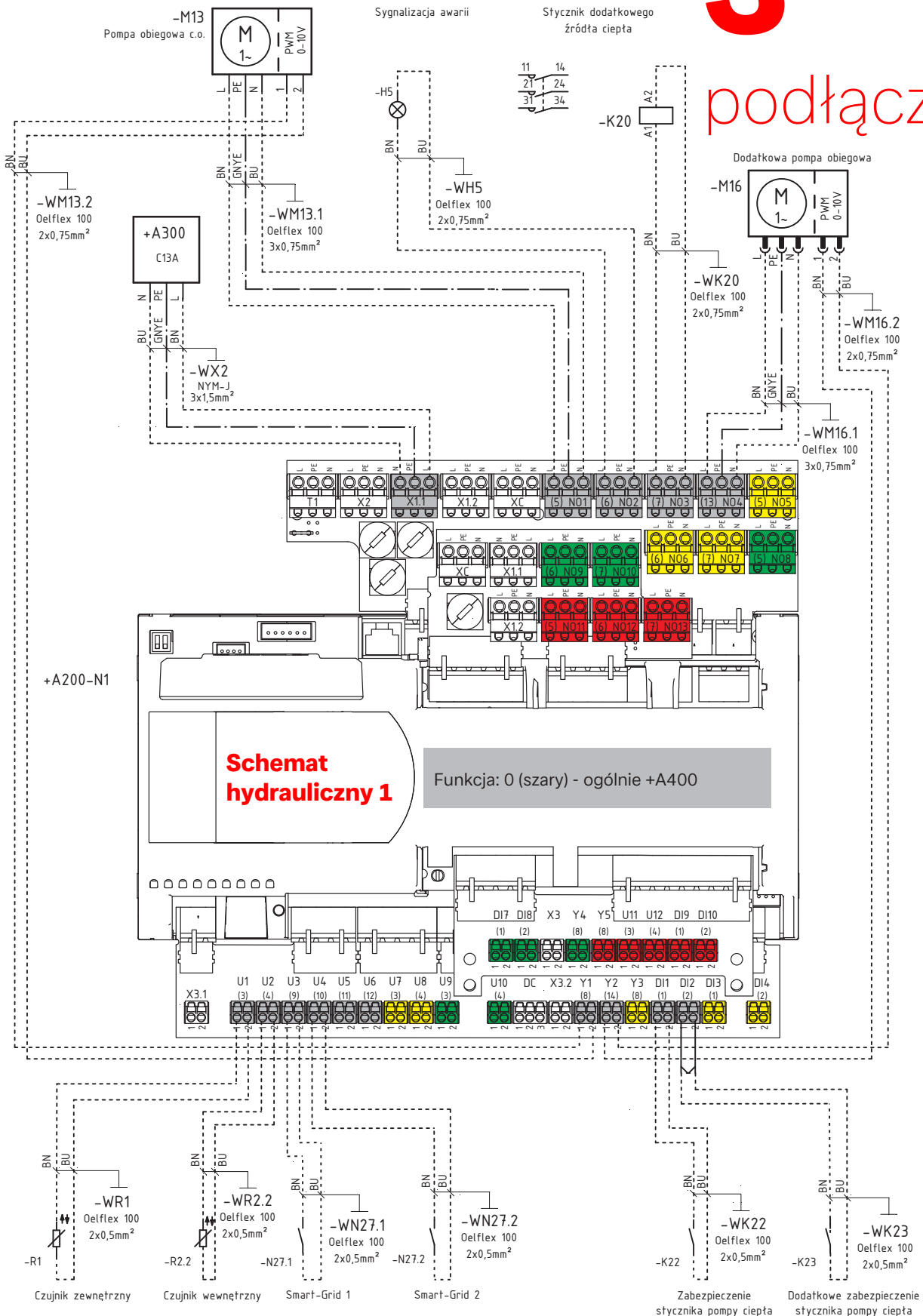

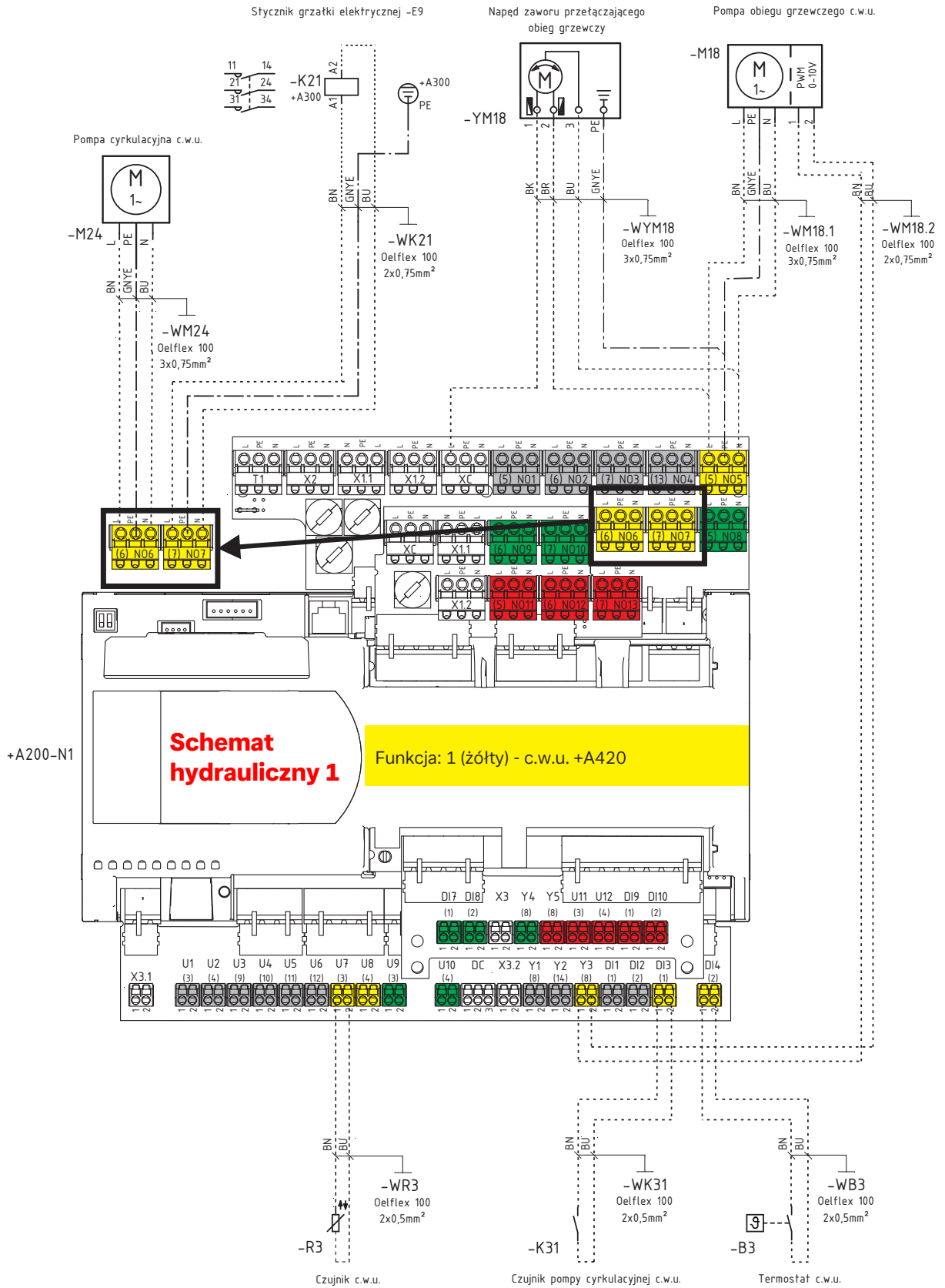

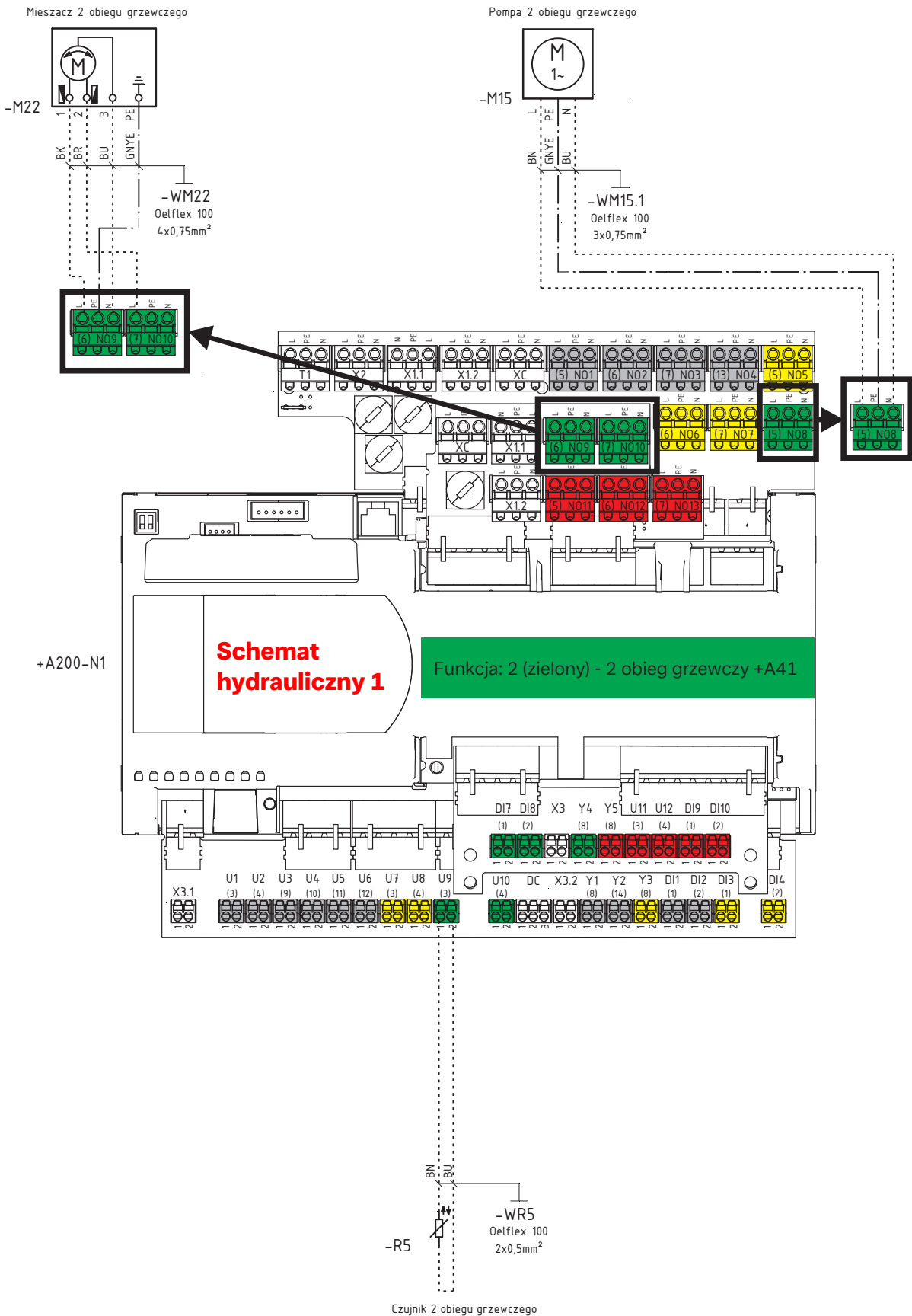

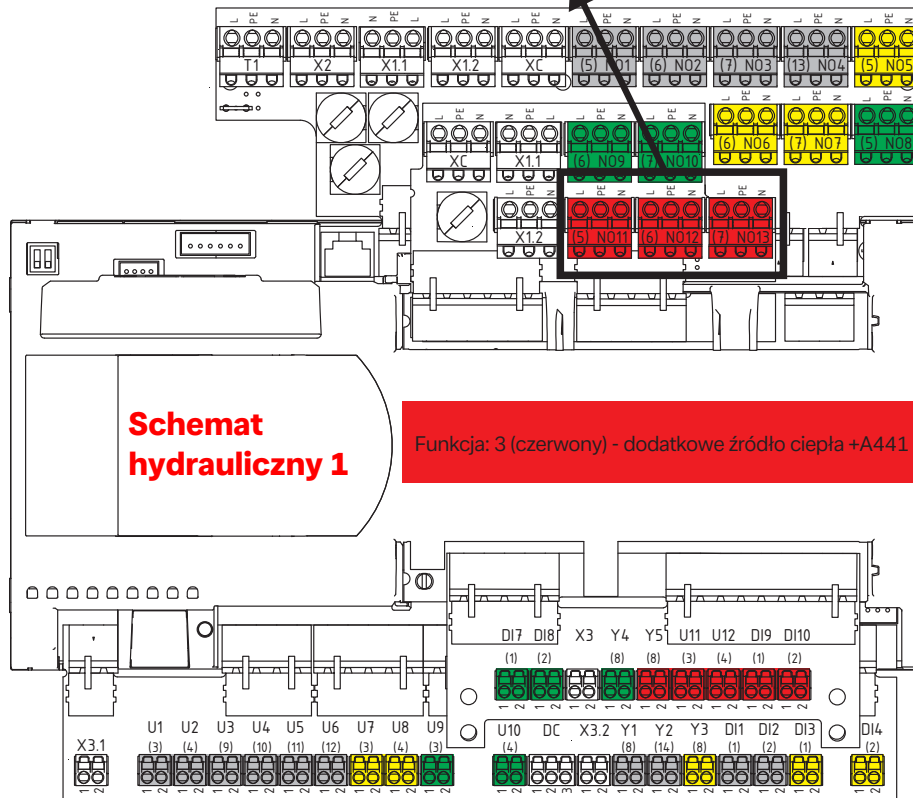
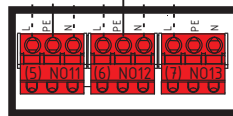
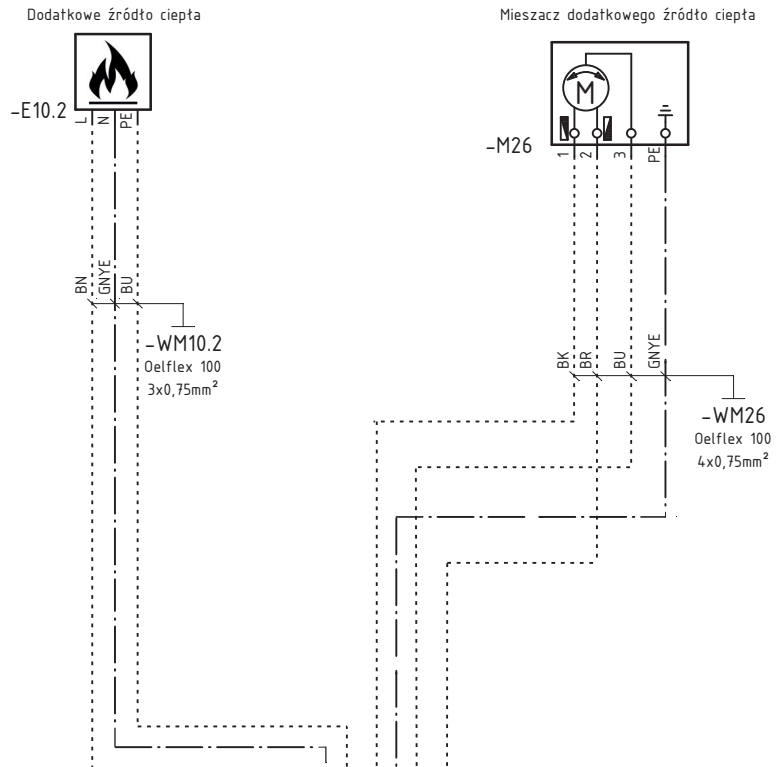

4



schemat hydrauliczny

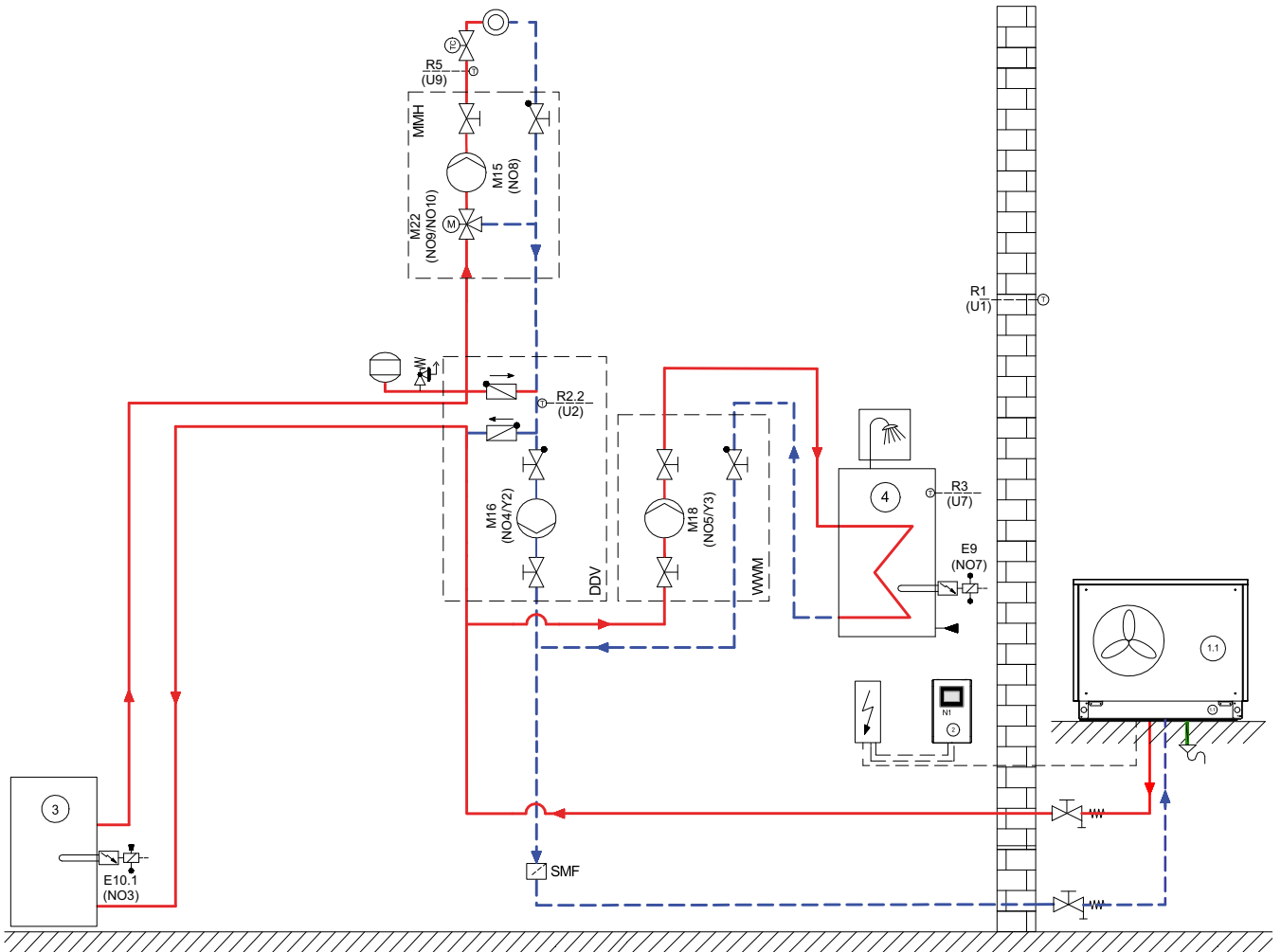

Schemat hydrauliczny 2

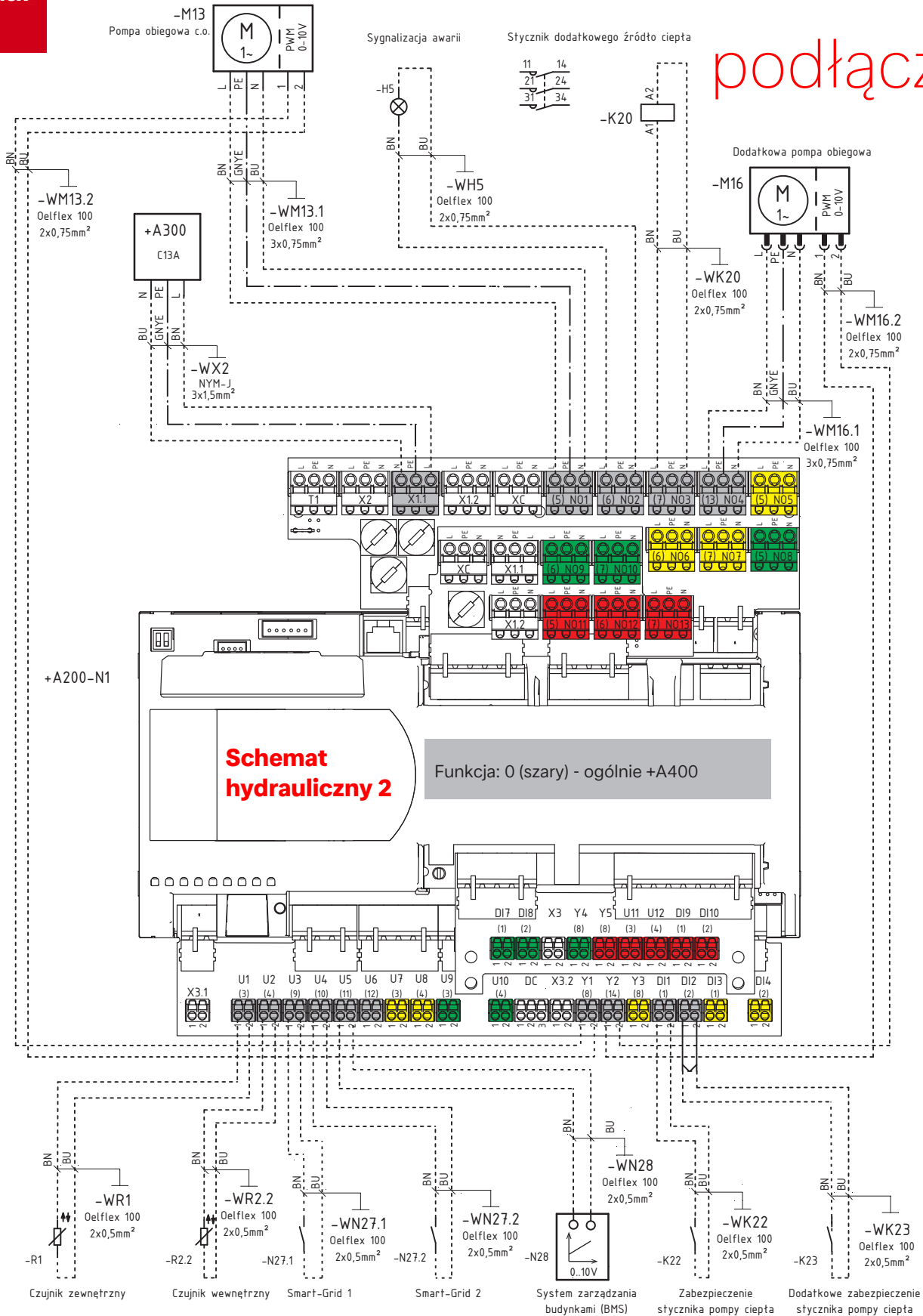

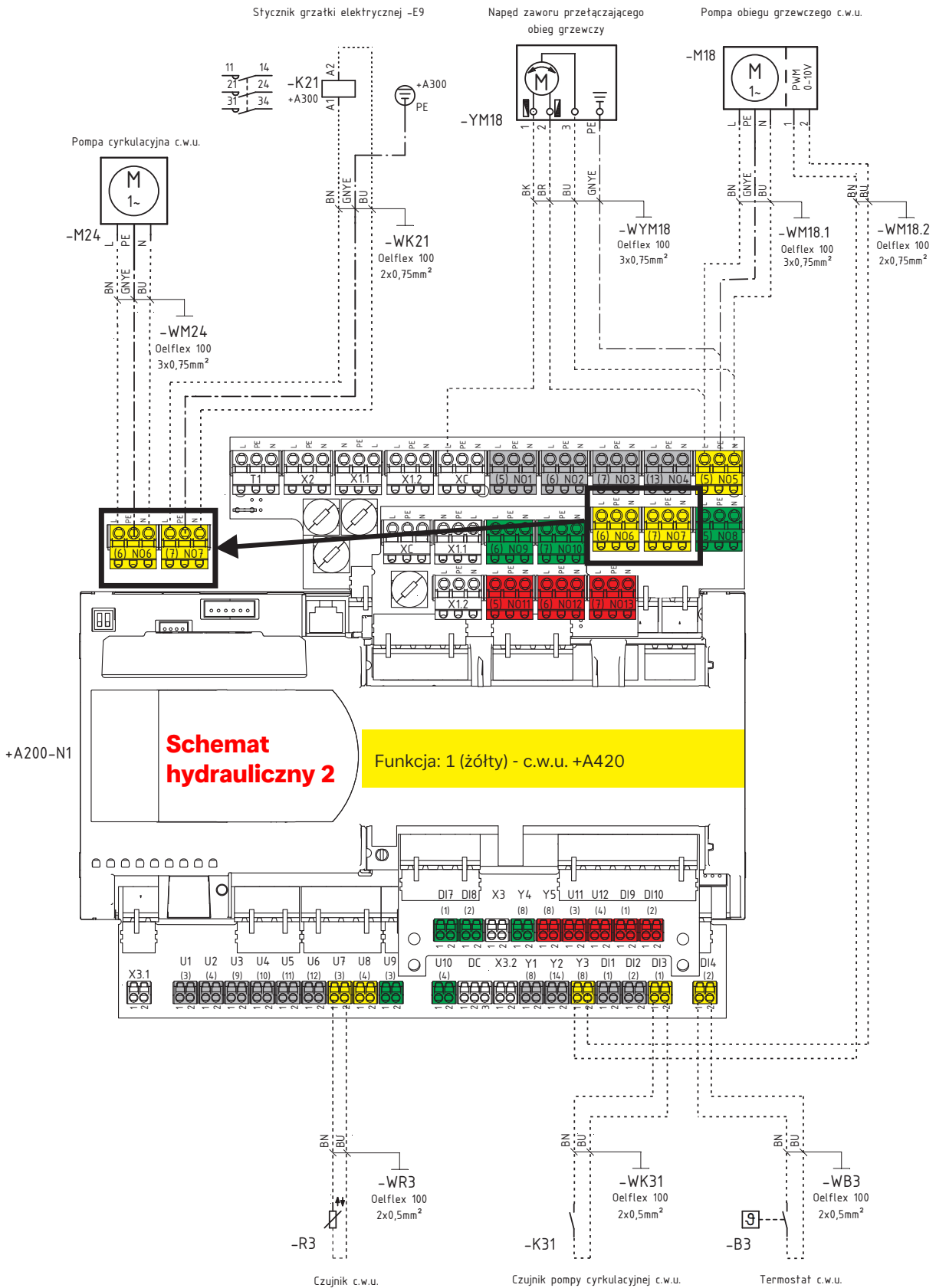



Glen
Dimplex
Deutschland

Dimplex

Mieszacz 2 obiegu grzewczego

Pompa 2 obiegu grzewczego

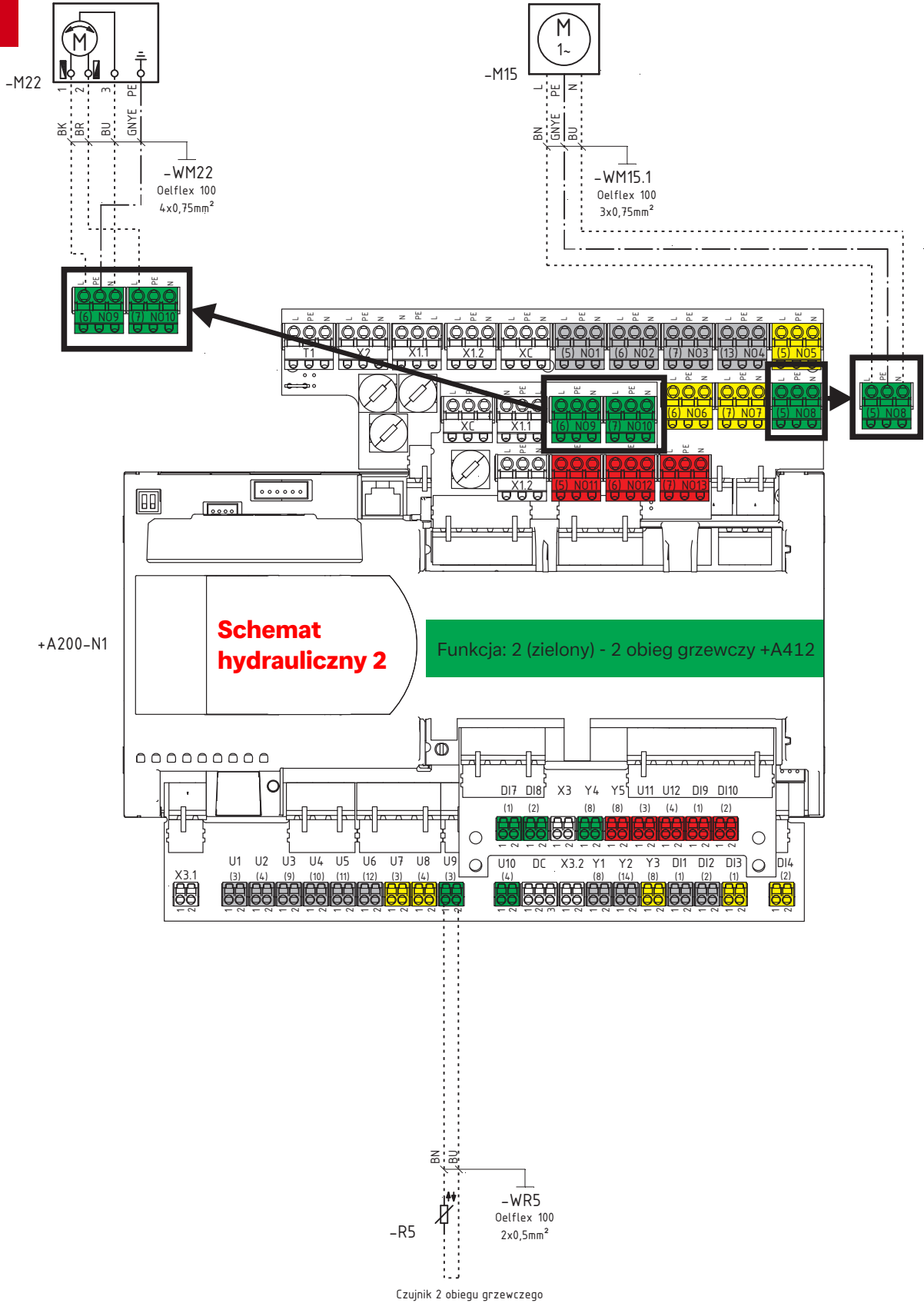

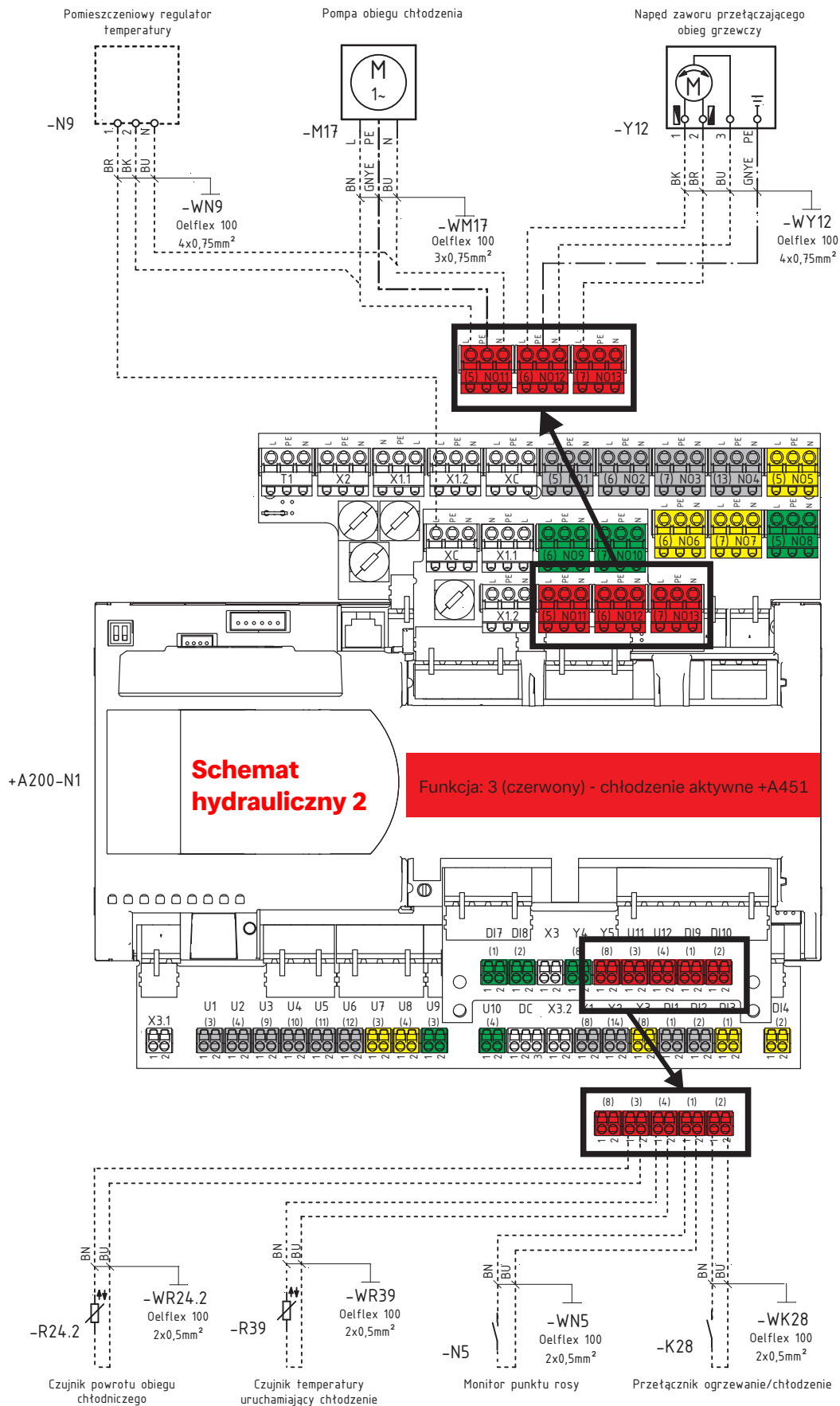



**Glen
Dimplex**
Deutschland

Dimplex